



Ultra Slim Design

TRI-SIGN™

With Ingenious Efficiency



TRI-SIGN FLEX READY MADE (Wall Mounted)

FLEX is-of-the-shelf, prefabricate with sophisticated look by spring loaded versatile sign system. It Can be installed & effortlessly constructed with double sided tape or by using the adjustable wall mount component that fit for frequent sign updates requirement such as hospital, corporate offices etc.

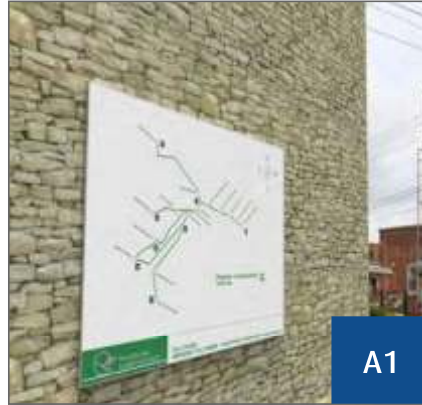

COMPONENTS

- A** TRI-FIX1-S
- B** TRI-FLEX2-S
- C** TRI-FLEX3-S
- D** TRI-SIGN SYNTHETIC BRACKET
- E** TRI-SIGN SPRING
- F** TLSCRW
- G** DOUBLE SIDED TAPE



TRI-SIGN FLEX READY MADE (Wall Mounted)

ASSEMBLY



POSSIBLE FRAME SIZES

Flex wall mounted frame sizes starts from 56.80mm x 152.8mm up to 598.8mm x 845.80mm

SECTION VIEW

ASSEMBLING

Trisign Flex ready made, wall mounted:

* Attached spring locked on the right side of the frame on TRIFLEX-3 Aluminum profile.

* Connect synthetic Angle on the left side of the frame on TRIFLEX-2 Aluminum profile.

* Reconnect 4 sides of frame for easy assemble, with TLSCRW on spring side.

MOUNTING POSSIBILITIES

- * Double Sided Tape
- * Glued with sticky plug

APPLICATIONS

- * Vinyl Lettering
- * Direct Digital Printing
- * Paper Insert

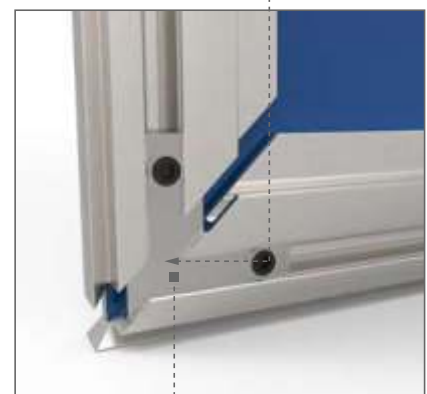

TRI-SIGN FLEX (Suspended)

Tri-sign Suspended sign is a contemporary sign that offer a stylish twist to create hanging directional system, and can be used either Tri-Sign system the FLEX or FIX application. Ideal for double sided sign and available in set of sizes for flexibility and durability.



COMPONENTS

- A** TRI-FIX1-S
- B** TRI-FLEX2-S
- C** TRI-FLEX3-S
- D** TRI-SIGN BRACKET
- E** TRI-SIGN SPRING
- F** TLSCRW
- G** DOUBLE SIDED TAPE
- H** TLOPH SUSPENSION

EXPLODED VIEW AND SECTION DETAILS

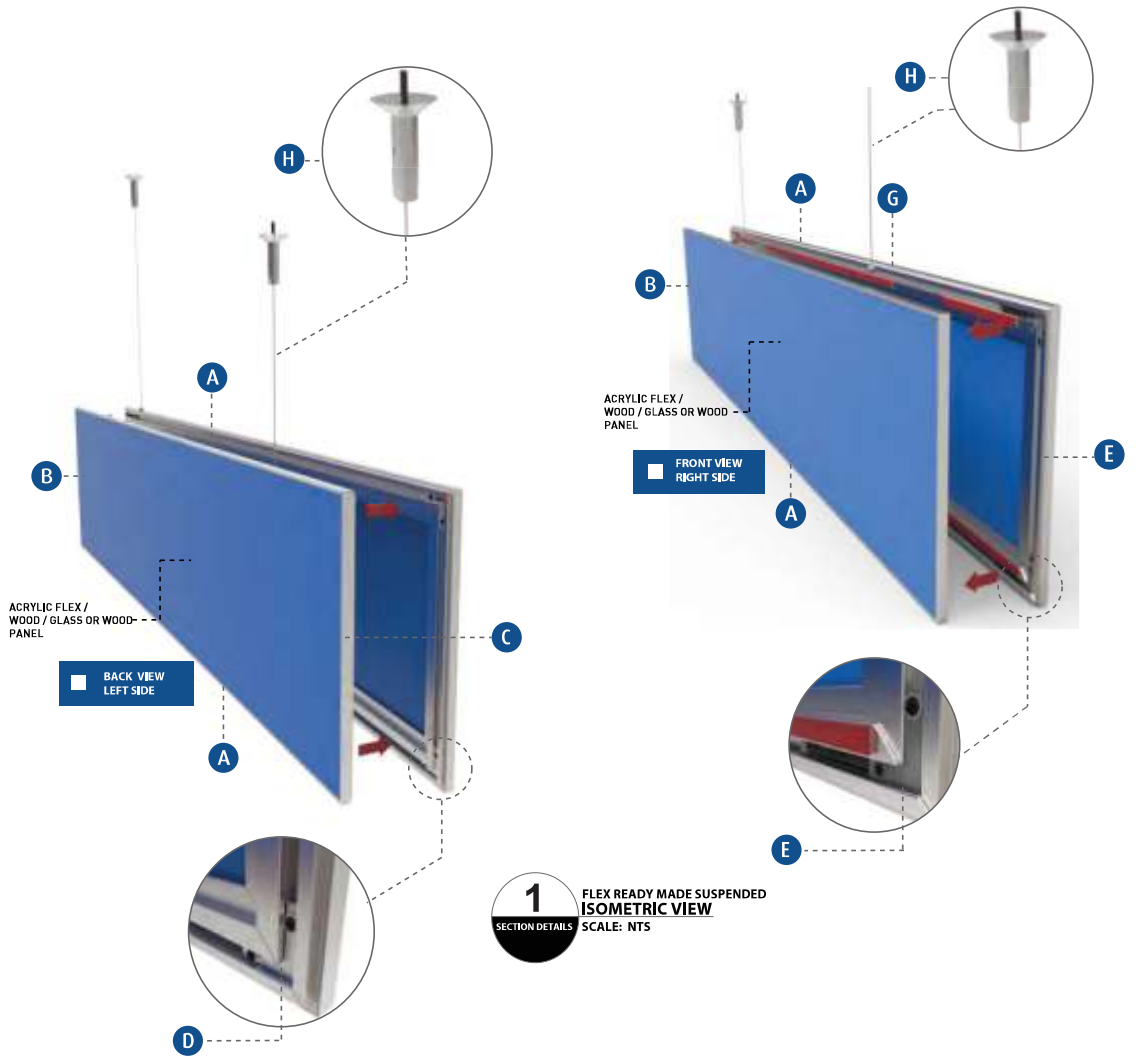

TRI-SIGN FLEX READY MADE (Suspended)

ASSEMBLY

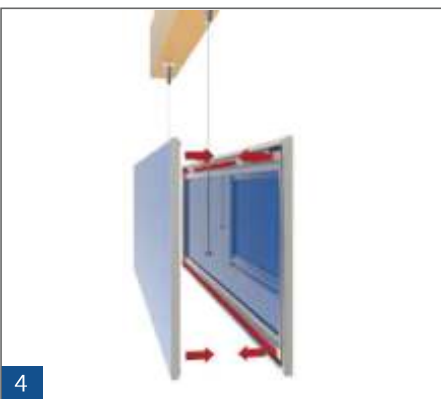

POSSIBLE FRAME SIZES
TRI-SIGN flex Ready Made wall mounted frame sizes starts from 148.5mm x 420mm up to 210mm x 840mm

SECTION VIEW

ASSEMBLING

Trisign Flex ready made, Suspended:

- * With Trisign Spring and bracket with assemble frame combined together to create a Flex or Clip suspension Frame Sign.
- * Connect synthetic Angle on the left side of the frame on TRIFLEX-2 Aluminum profile.
- * Reconnect 4 sides of frame for easy assemble, with TLSCRW on spring side.

MOUNTING POSSIBILITIES

- * Double Sided Tape
- * Glued with sticky plug

APPLICATIONS

- * Vinyl Lettering
- * Direct Digital Printing
- * Paper Insert

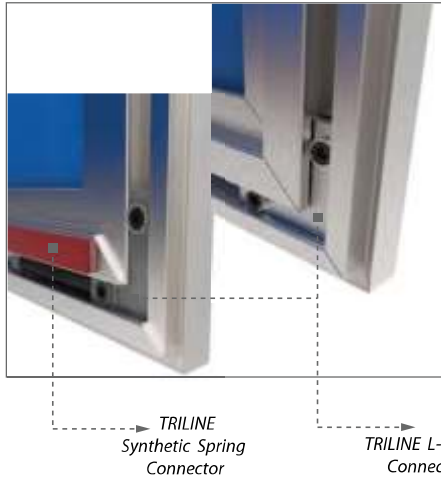
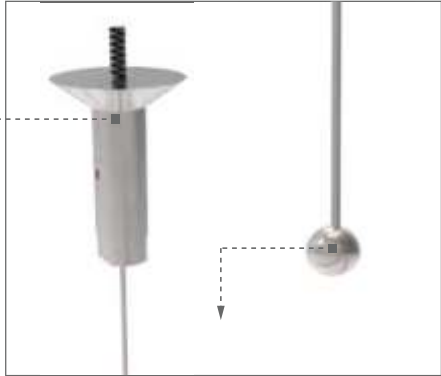
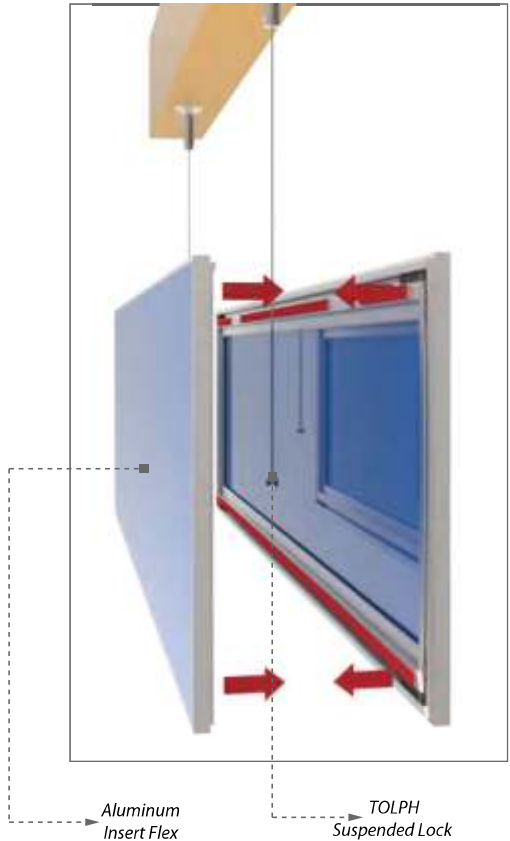

TRI-SIGN FLEX READY MADE (Projected)

Is a prestigious signage system with a stunning anodized finished and can be used either Tri-sign Flex or Tri-Sign Fix Application. Ideal for double sided and available in set of sizes for flexibility and durability.

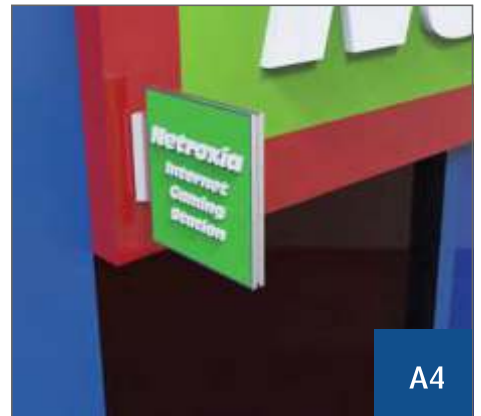
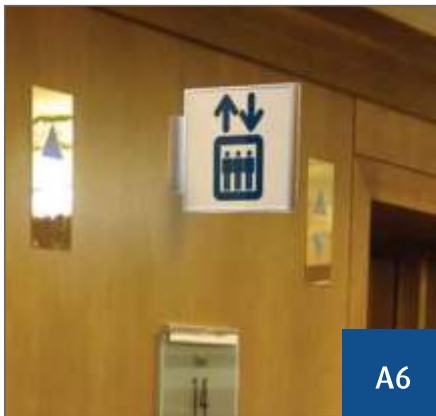

COMPONENTS

- A** TRI-FIX1-S
- B** TRI-FLEX2-S
- C** TRI-FLEX3-S
- D** TRI-SIGN BRACKET
- E** TRI-SIGN SPRING
- F** TLSCRW
- G** TRI-D160-S
- H** TRI-SIGN PROJECTED HOLDER
- I** DOUBLE SIDED TAPE

SECTION DETAILS EXPLODED VIEW

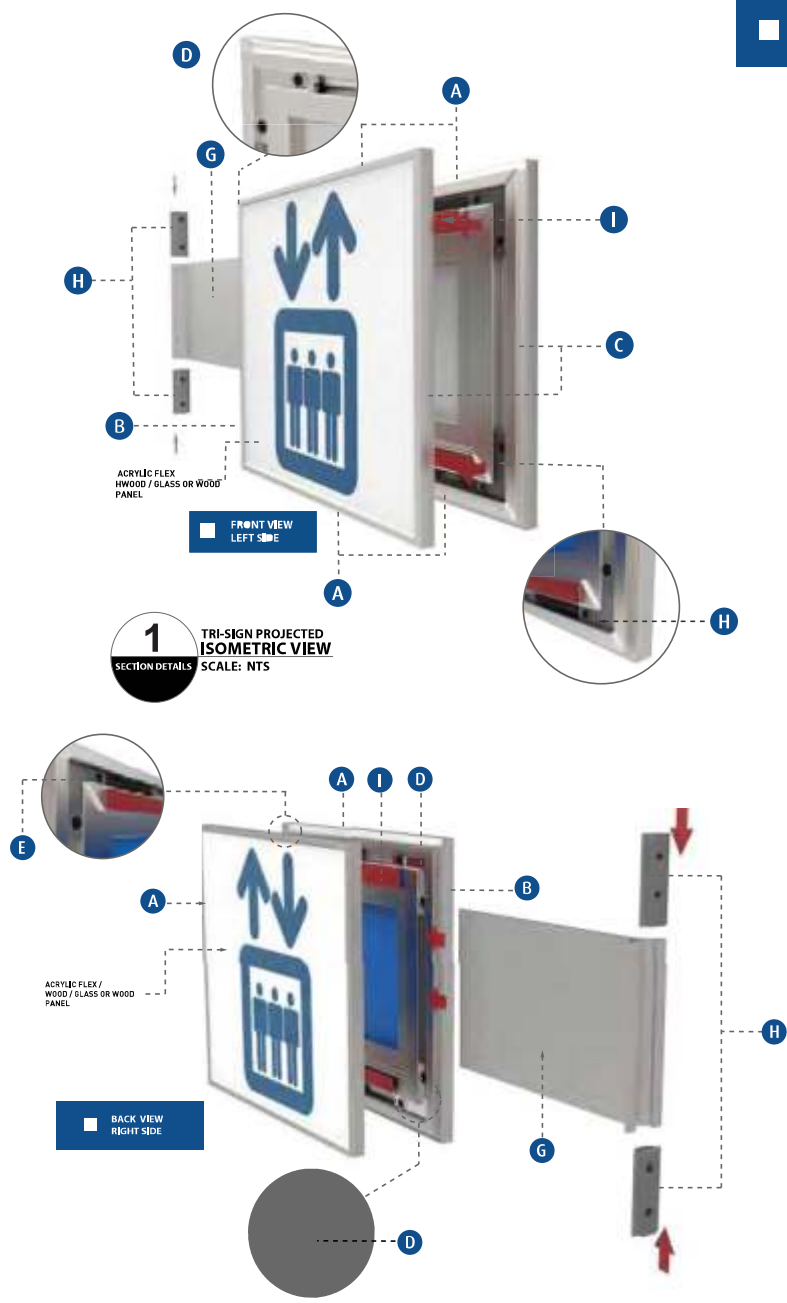

TRI-SIGN FLEX READY MADE (Projected)

ASSEMBLY

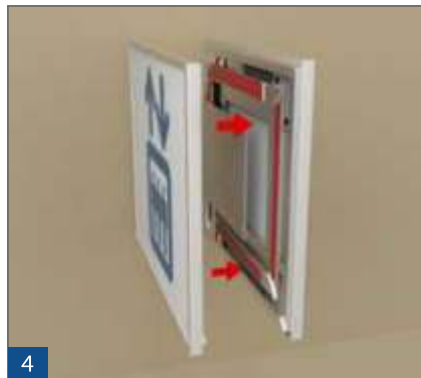
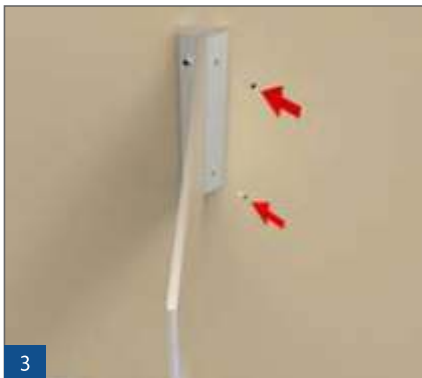
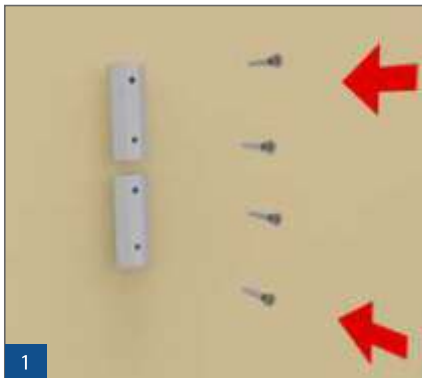

ASSEMBLING

Trisign Flex ready made, Projected:

- * With Trisign Spring and bracket with assemble frame combined together to create a Flex or Clip projected Frame Sign.
- * Connect synthetic Angle on the left side of the frame on TRIFLEX-2 Aluminum profile.
- * Reconnect 4 sides of frame for easy assemble, with TLSCRW on spring side.

MOUNTING POSSIBILITIES

- * Double Sided Tape
- * Glued with sticky plug

APPLICATIONS

- * Vinyl Lettering
- * Direct Digital Printing
- * Paper Insert

SECTION VIEW

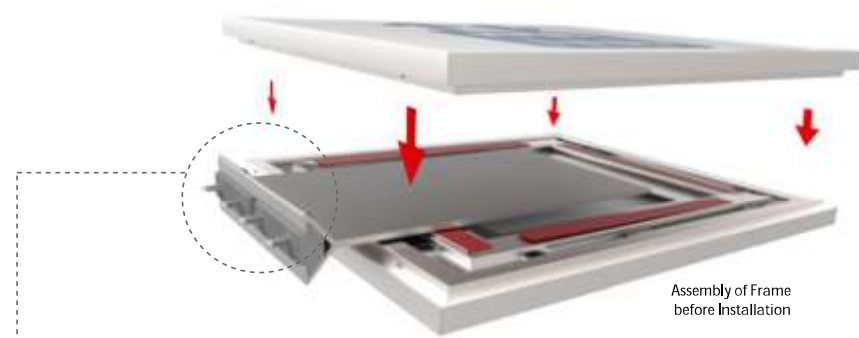

Assembly of Frame before Installation

2 FLEX READY MADE (PROJECTED)
SECTION DETAILS ISOMETRIC VIEW
SCALE: NTS



TRI-SIGN CLIP FIX (Wall Mounted)

Fix provides a reliable way and easy to mount using double sided tape which don't require constant changes to create contemporary system for offices, hospital, etc. Frames are suited for customized materials once constructed.

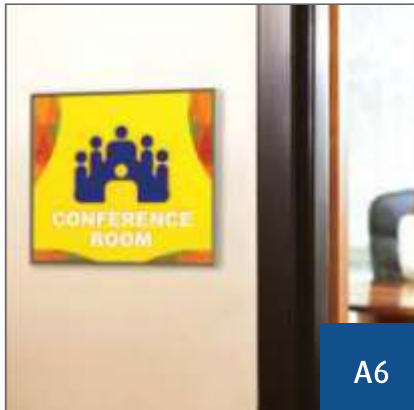

SECTION DETAILS

COMPONENTS

- A** TRI-FIX1-S
- B** SYNTHETIC CLIP
- C** TRI-SIGN SYNTHETIC BRACKET
- D** DOUBLE SIDED TAPE
- D** TLSCRW / ALLEN SCREW

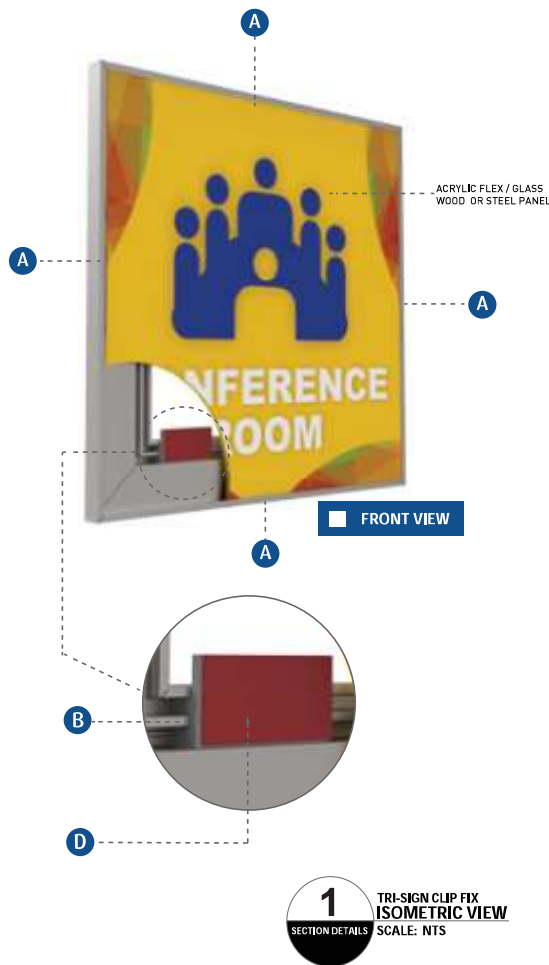

CLIP FIX READY MADE (Wall Mounted)

ASSEMBLY

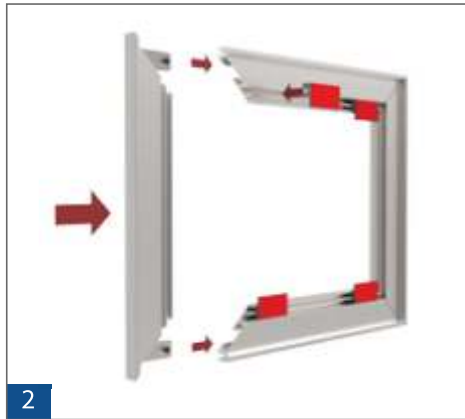

SECTION VIEWS

ASSEMBLING

Trisign Clip Fix Ready made, wall mounted:

*Connect synthetic Angle on all sides of the frame using TRI-FIX1-s Aluminum profile.

* Reconnect 4 sides of frame for easy assemble, with TLSCRW on spring side.

* Synthetic clip fix holds Aluminum plate material with glued 3M adhesive material.

MOUNTING POSSIBILITIES

- * Double Sided Tape
- * Glued with sticky plug

APPLICATIONS

- * Vinyl Lettering
- * Direct Digital Printing
- * Paper Insert

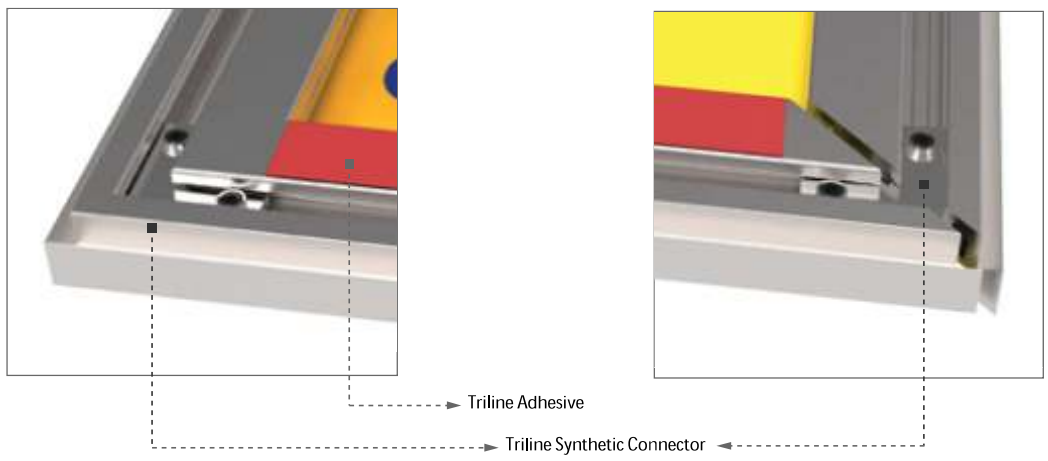
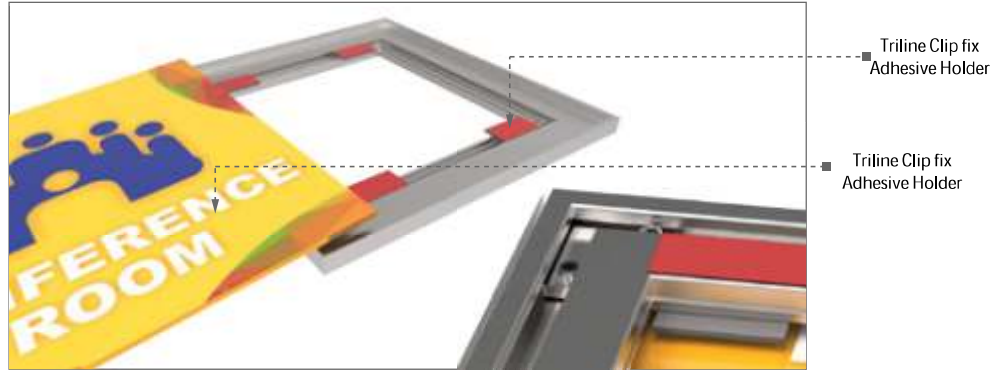

TRI-SIGN FLAG (Projected)

Tri-sign Flag is a complex solution that incorporate infinite flexibility. Easy to install a double sided sign version for internal & external application and can be used in direct print and braile application.



A4



A6



A5

COMPONENTS

- A**  TRI-D160-S
- B**  TRI-SIGN PROJECTED HOLDER
- C**  TLSCRW
- D**  TLSCRW

SECTION DETAILS EXPLODED VIEW



TRI-SIGN FLAG (Projected)

ASSEMBLY



ASSEMBLING

TRISIGN FLAG (PROJECTED)

* With TRISIGN FLAG frame combined together to create projected dynamic flag type design

* With special TRI-SIGN TLOPH-D160-S holder, flag sign made it easy to assemble.

MOUNTING POSSIBILITIES

* Wall mounted with screw

APPLICATIONS

- * Vinyl Lettering
- * Direct Digital Printing
- * Braille text

POSSIBLE FRAME SIZES

Flag Sign (Projected)
fixed 160mm on length
up to 4500mm width

SECTION VIEW

