



TRI-POSTS™

Post & Panel, Totems, Pylons and much more



Pylon Sign

This item is the most flexible product for the multiple applications solution, a feature that only Triline Systems is offering to the market, satisfying to a wide range of demands.



COMPONENTS

- A** TLSCR5-S
- B** TLJE90-900-B
- C** TLSLO
- D** TLTE90-S
- E** TLB50-S
- F** TLSV90
- G** TLEV90-900-B
- H** TLSCR4-S
- I** TLSCR6-S



PYLON SIGN

Assembly and Section Details

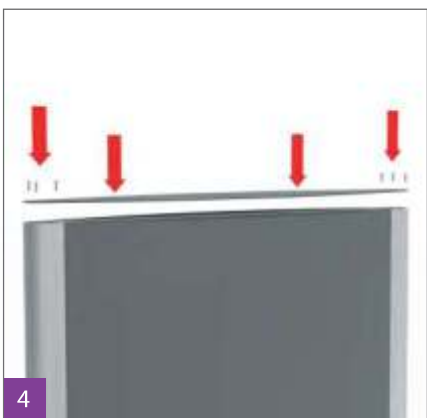

■ APPLICATIONS

- * Directional Pylon Signs
- * Pylon Corporate Signs

■ MOUNTING POSSIBILITIES

- * Using TLSV90 - Support standee is so easy to assemble.

■ SECTION DETAILS

- * Using TLSV90 - TLIE90- 900 BASE
- Basic Colors
 - Silver
 - Gray
- * PROFILES have standard length of 3500 -4500mm
- * Standard Finish:
 - Mill
 - Silver Anodized

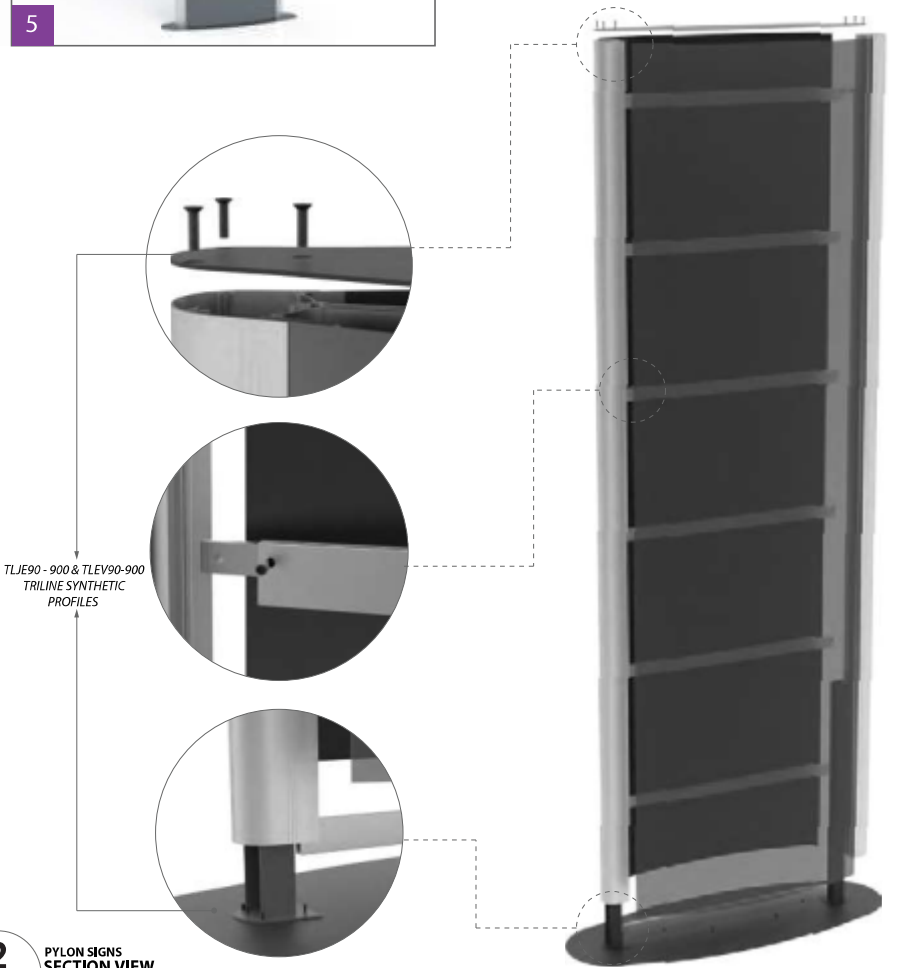

2 PYLON SIGNS
SECTION DETAILS
SECTION VIEW
SCALE: NTS

Posts & Panels

2 standard posts of 60mm & 90mm with 1 slot, 4 standard profiles with two locking possibilities.

A fixation profile that makes any exterior creation possible.

A new adapter profile that gives more stability when thin plate materials are used like aluminum or steel.

Ideal for personnel signs, parking signs, flag signs, directional signs, stands and more...



COMPONENTS

- A** TLSCR4,5 & 6-S
- B** TLDOPR90-B
- C** TLSLO
- D** TLPR90-S
- E** TLBPE-S
- F** TLBEV-S
- G** TLBTP-B
- H** TLAD4-S
- I** TLB50-S
- J** TLB100-S
- K** TLB200-S
- L** TLOPV-S
- M** TLSV90

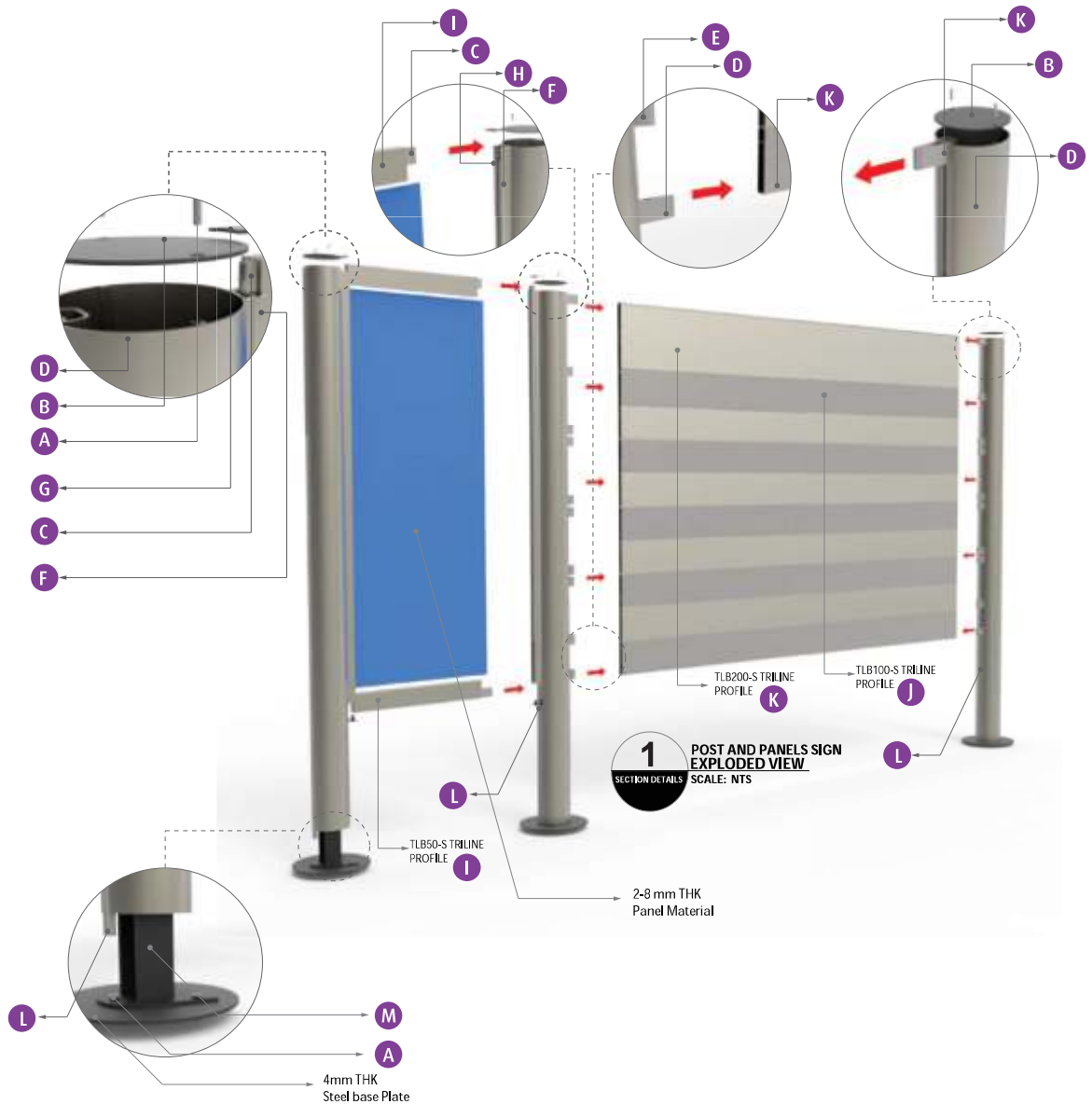

POSTS AND PANELS SIGN

Assembly and Section Details

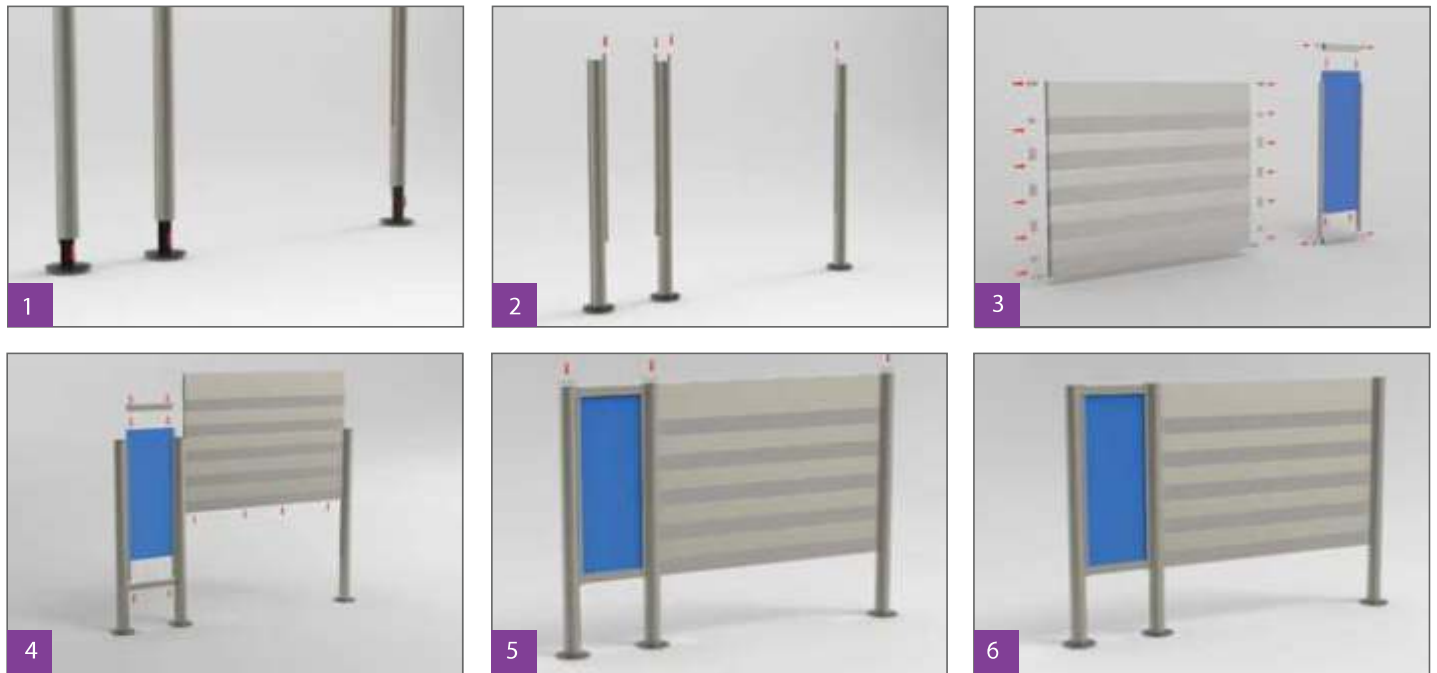

- APPLICATIONS**
- * Ideal for parking Signs
 - * Flag Signs
 - * Directional Signs
 - * Standee Signs and more..
- MOUNTING POSSIBILITIES**
- * Using TLSV90 - Support standee is so easy to assemble.



Directory Sign

Modular and durable. A sign family made by Triline suitable for indoor and outdoor applications. Possibility to make standard to custom-size signs based on your requirements.

Triposts - makes sign fabrication and assembly fast, simple & easier without compromising aesthetic and effectivity.



- COMPONENTS**
- A** TLSCR4 5 & 6-S
 - B** TLTSCAP80-900
 - C** TLOPV-S
 - D** TLTMSPP80-S
 - E** TLSLO
 - F** TLB50-S
 - G** TLCLJ-B
 - H** TL31S-S
 - I** TLPAN-S
 - J** TL155S-S
 - K** TL62-S
 - L** TLONP-S
 - M** TL217S-S
 - N** TLTSBASE80-900
 - O** TLSV90

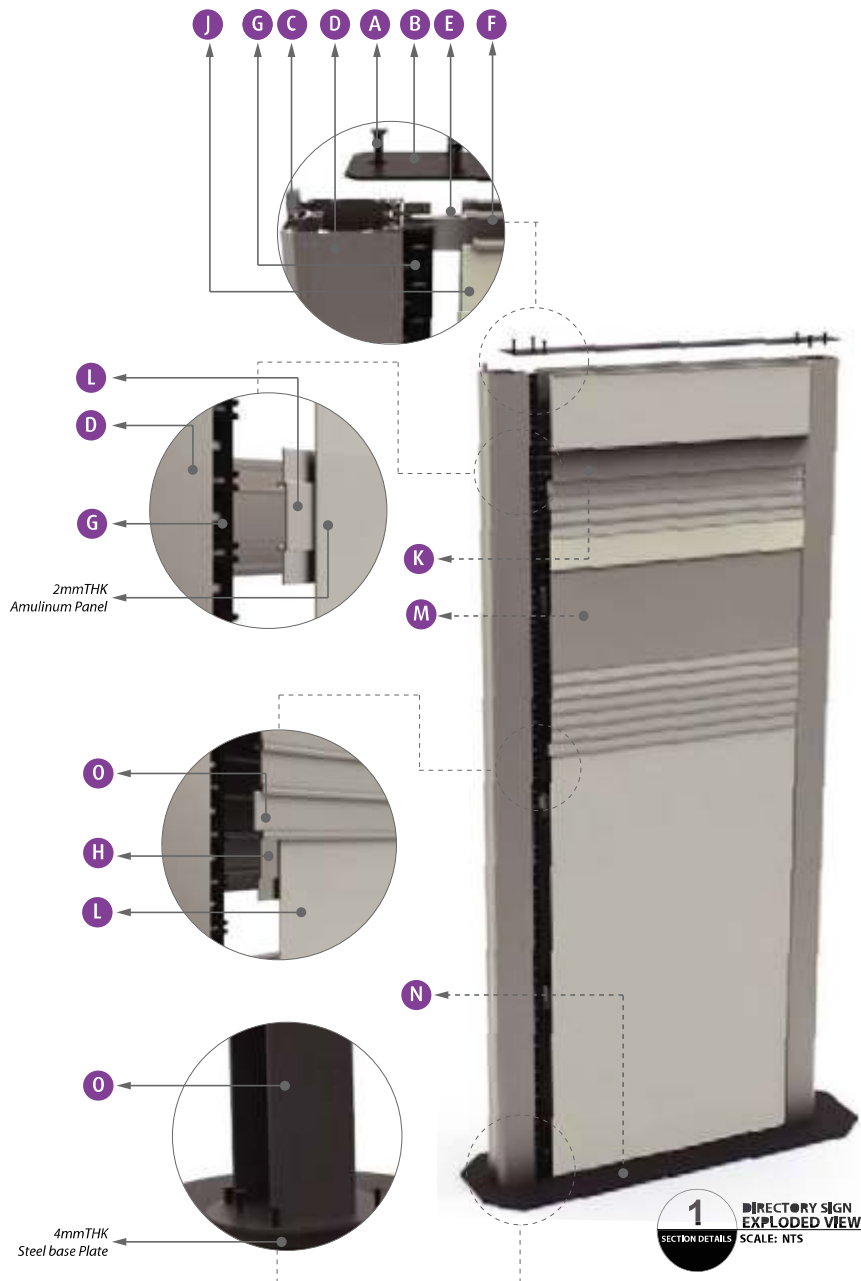

POSTS AND PANELS SIGN

Assembly and Section Details



- APPLICATIONS**
- * Ideal for Interior Directory Sign
 - * Corporate Directional Signs
 - * Standee Signs and more..
- MOUNTING POSSIBILITIES**
- * Using TLSV90 - Support standee is so easy to assemble.

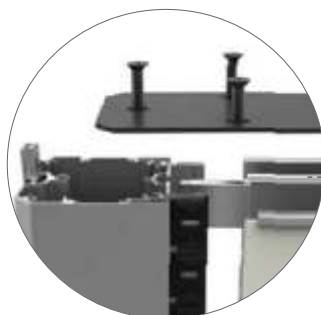

TRILINE - Combined with Splendid and Alliances Components (TLOPV & TLCLJ) Synthetic Lock to the Tri-Post TLTMSP80 with Synthetic Cover Plate.



TRILINE - Combined with Splendid and Alliances Components (TLOPV & TLCLJ) to the Tri-Post TLTMSP80 with Synthetic Cover Plate.

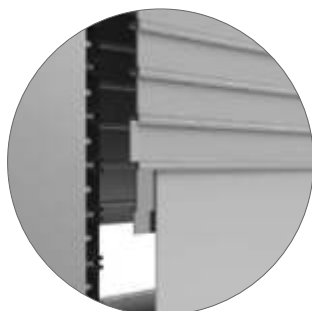

TRIPOST CONNECTORS
Tri-Post TLB50 and TLSLO
Joining Alliance Insert and face Profiles with TLPAN for stability purpose - see drawing below

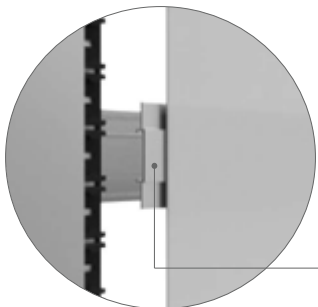

TLPAN Alliance Profiles













2 DIRECTORY SIGNS
SECTION DETAILS
SCALE: NTS

Single Post Sign

Another high-end and very much premium with innovative design that offer a range of small, medium to large signs. Allowing the display sign to fit together using only basic assembly tools.



COMPONENTS

- A**  TLSCR4 5 & 6-S
- B**  TLBEV-S
- C**  TLDOPR90-B
- D**  TLPR90-S
- E**  TLBTP-B
- F**  TLOPV-S
- G**  TLPBE-S
- H**  TLB150-S
- I**  TLBE150-B
- J**  TLSV90

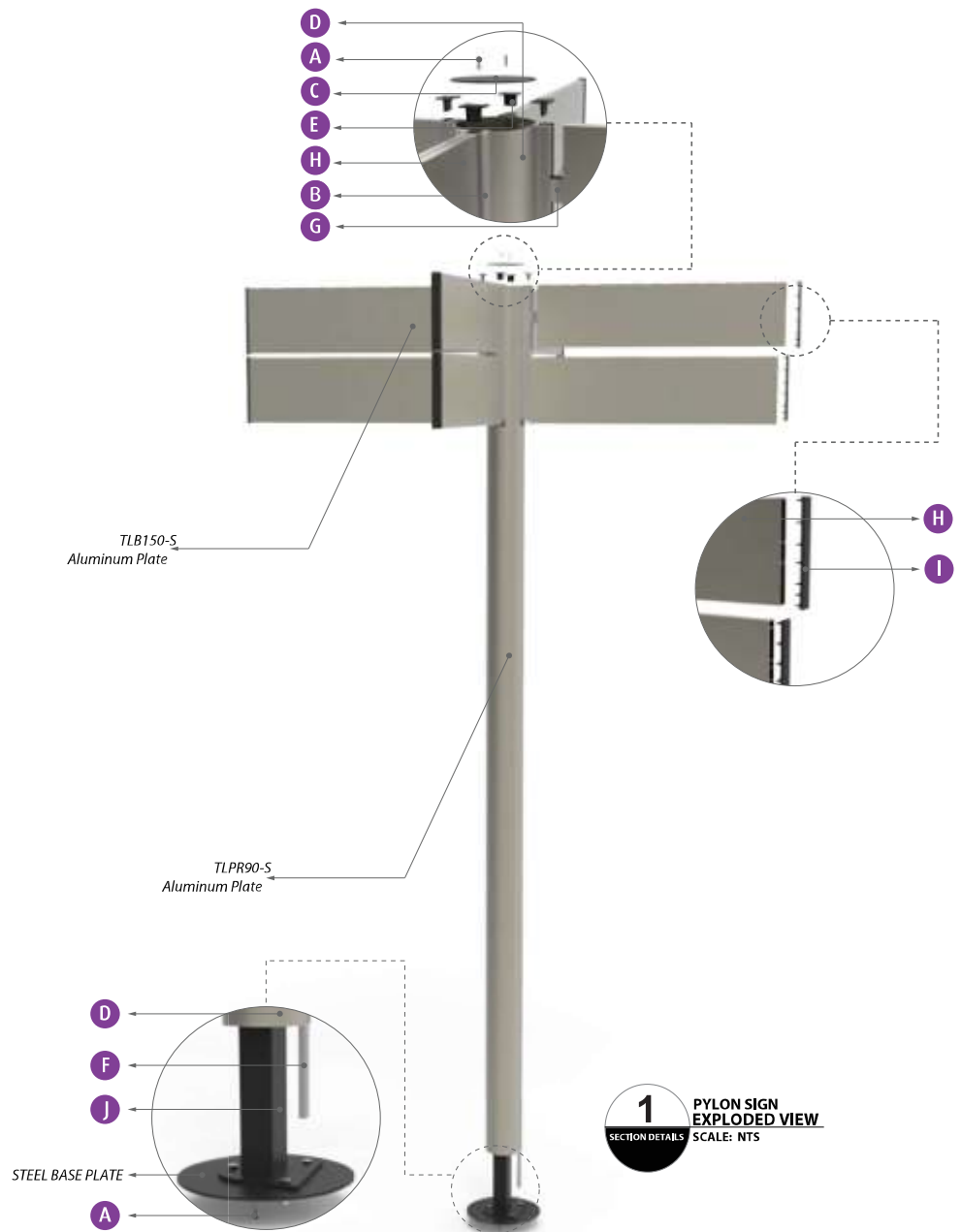

POSTS AND PANELS SIGN

Assembly and Section Details

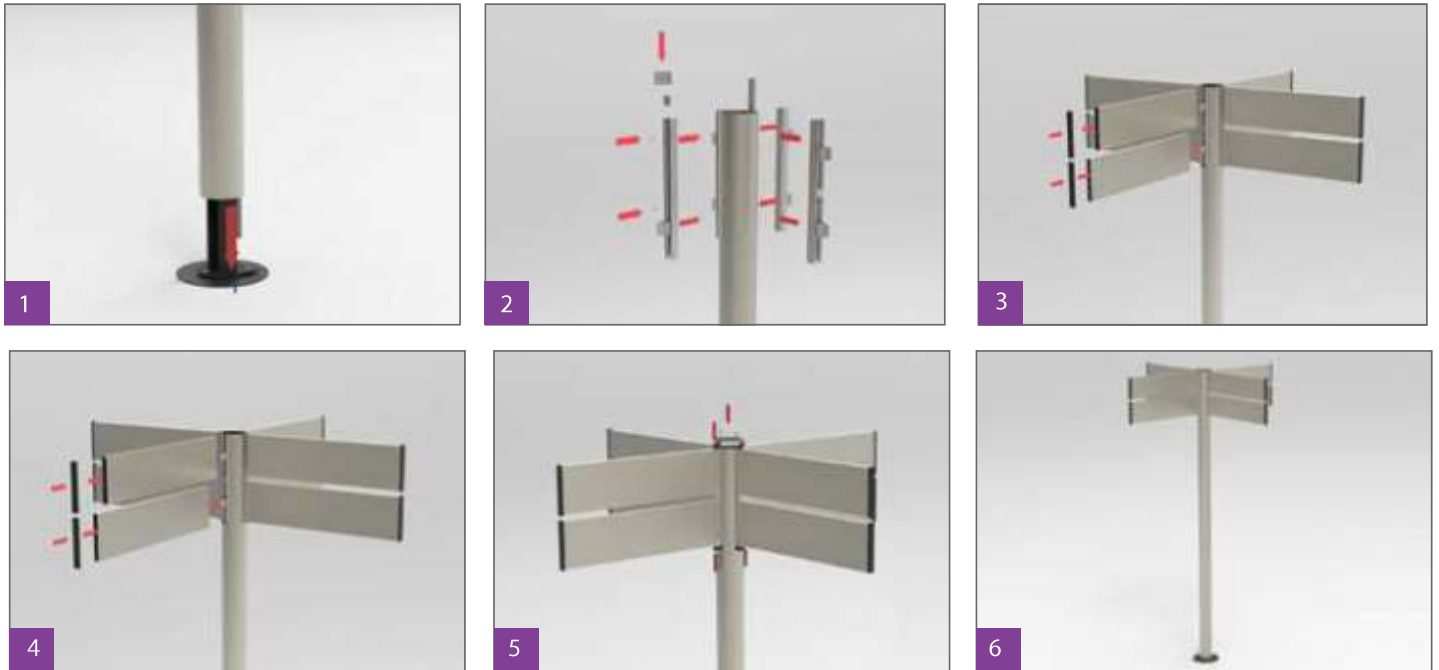

■ APPLICATIONS

- * Ideal for Exterior Parking Sign
- * Corporate Directional Signs
- * Standee Signs and more..

■ MOUNTING POSSIBILITIES

- * Using TLSV90 - Support standee is so easy to assemble.

