



Convex Design

# HI-TECH™

with Assorted Frame Options



## Convex Insert Wall Signs (Radius)

The convex profile is slide in the TLHTFIX (antivandalism) profile. You can extend the convex sign with insert profiles in 3 different looks: square, round and ellipse. Finish with synthetic single end-caps square (from 93 to 248 mm), round or ellipse (from 93mm to 297mm). Easy assembly.

Ideal for personnel signs, room identification, wall projection signs, emergency signage and more.

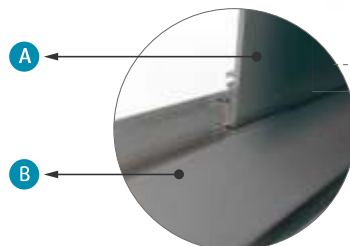
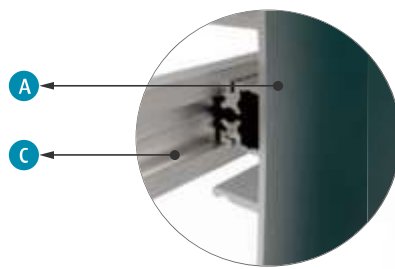
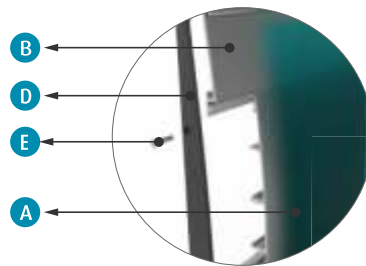

**COMPONENTS**

- A**  TLHT217-S
- B**  TLHTFRA3-S
- C**  TLHTFIX-S
- D**  TLHTER297-B
- E**  TLSCR8-S

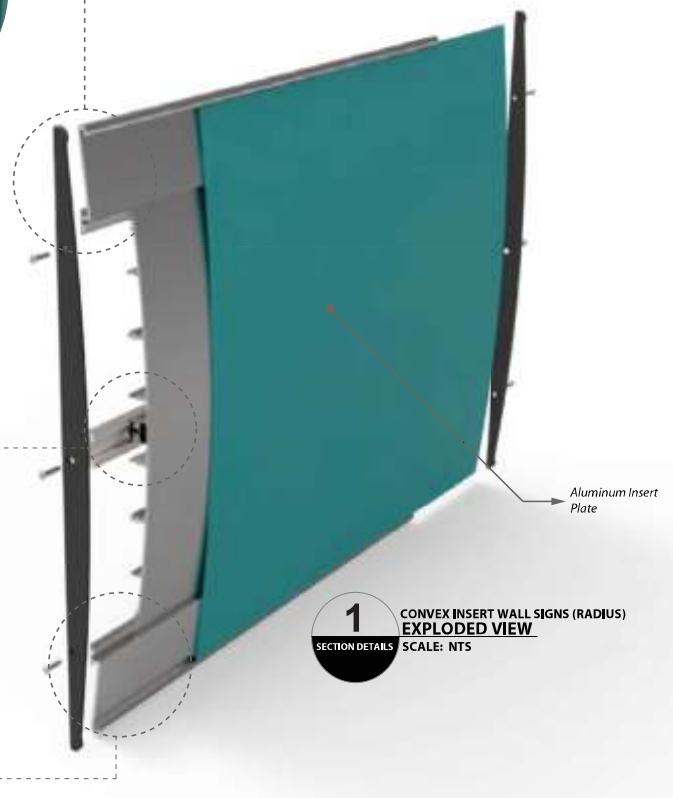

CONVERT INSERT WALL SIGN (Radius)

Assembly and Section Details

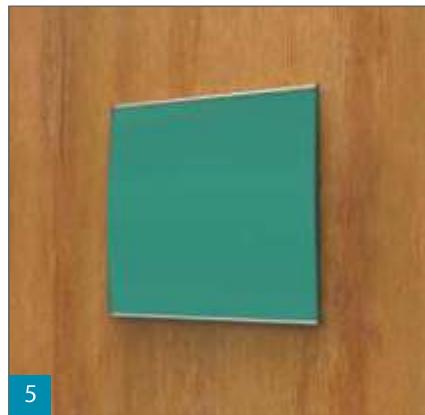
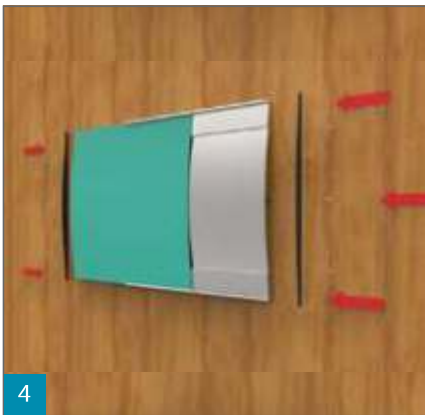
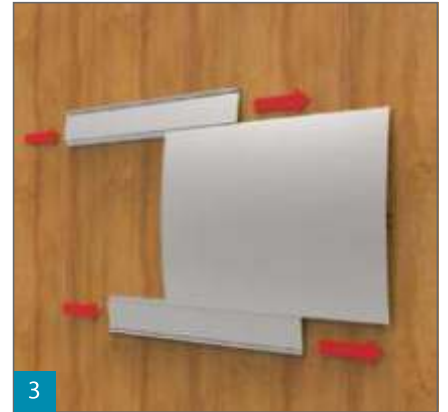
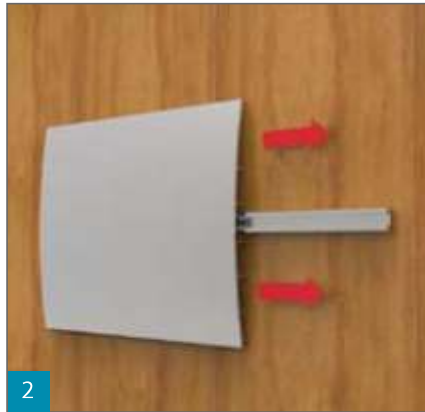

- APPLICATIONS**
  - \* Personal Signs
  - \* Room Identifications
  - \* Wall Projections Signs
  - \* Emergency Signs
- MOUNTING POSSIBILITIES**
  - \* With double adhesive for wall mounting.
- SECTION DETAILS**
  - \* Using TLHTFIX-S basic colors:
    - Silver
    - Gray
  - \* PROFILES have standard length of 3500 mm
  - \* Standard Finish:
    - Mill
    - Silver Anodized

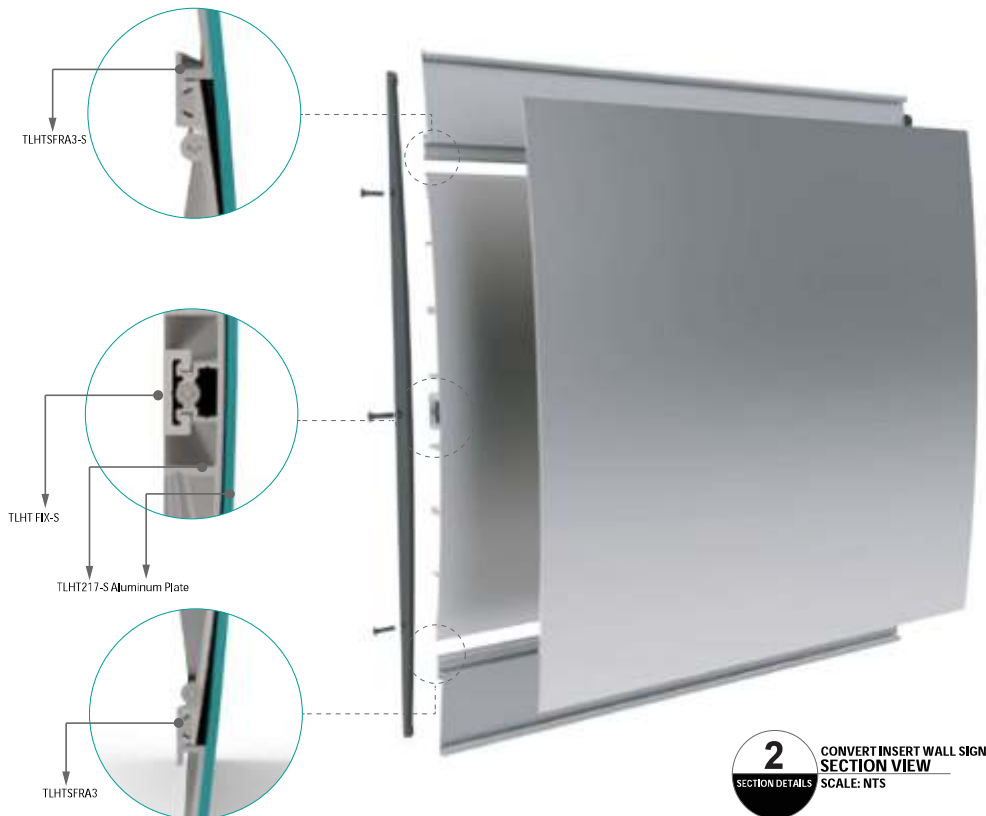

## Convex Insert Wall Sign (Square)

The convex profile is slide in the TLHTFIX (antivandalism) profile. You can extend the convex sign with insert profiles in 3 different looks: square, round and ellipse. Finish with synthetic single end-caps square (from 93 to 248 mm), round or ellipse (from 93mm to 297mm). Easy assembly.

Ideal for personnel signs, room identification, wall projection signs, emergency signage and more.



COMPONENTS	
A	TLHT124-S
B	TLHTSES155-B
C	TLHTSFS-S
D	TLHTFIX-S
E	TLSCR7-S
F	TLSCR8-S

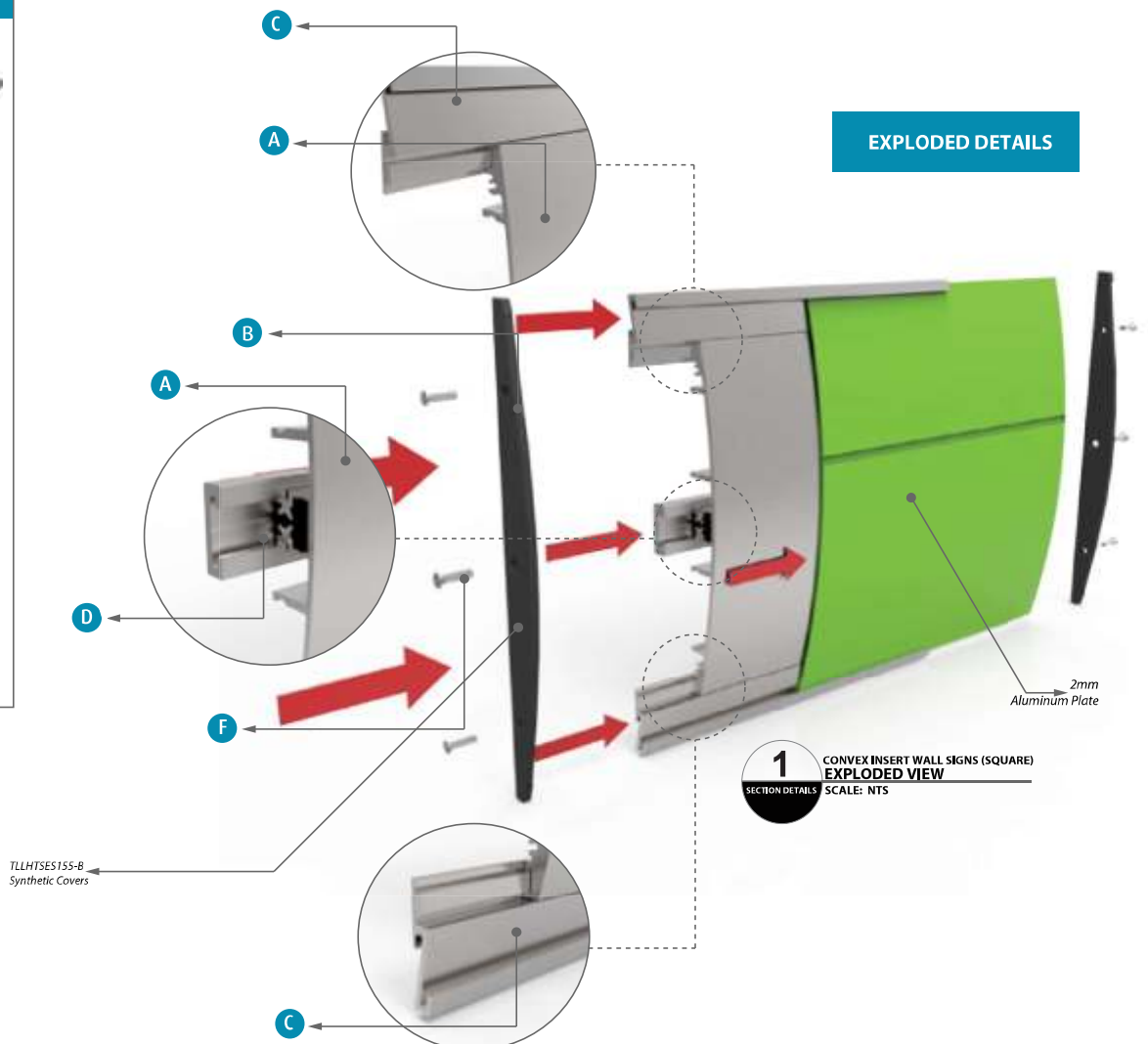

## CONVERT INSERT WALL SIGN (Square)

### Assembly and Section Details

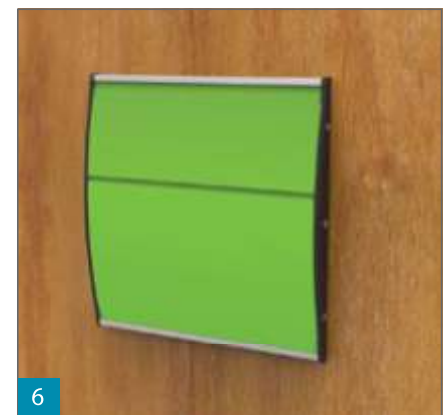
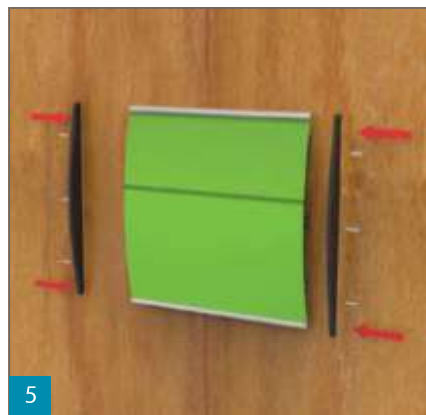
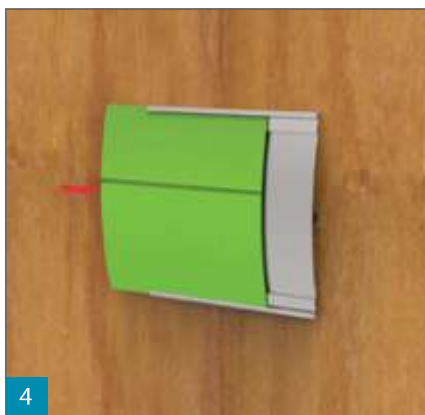
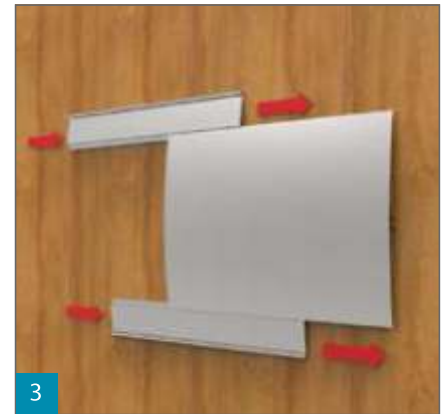
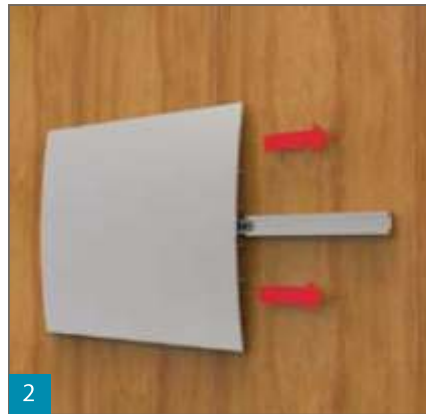

**■ APPLICATIONS**

- \* Personal Signs
- \* Room Identifications
- \* Wall Projections Signs
- \* Emergency Signs

**■ MOUNTING POSSIBILITIES**

- \* With double adhesive for wall mounting.

**■ SECTION DETAILS**

- \* Using TLHTFIX-S basic colors:
  - Silver
  - Gray
- \* PROFILES have standard length of 3500 mm
- \* Standard Finish:
  - Mill
  - Silver Anodized

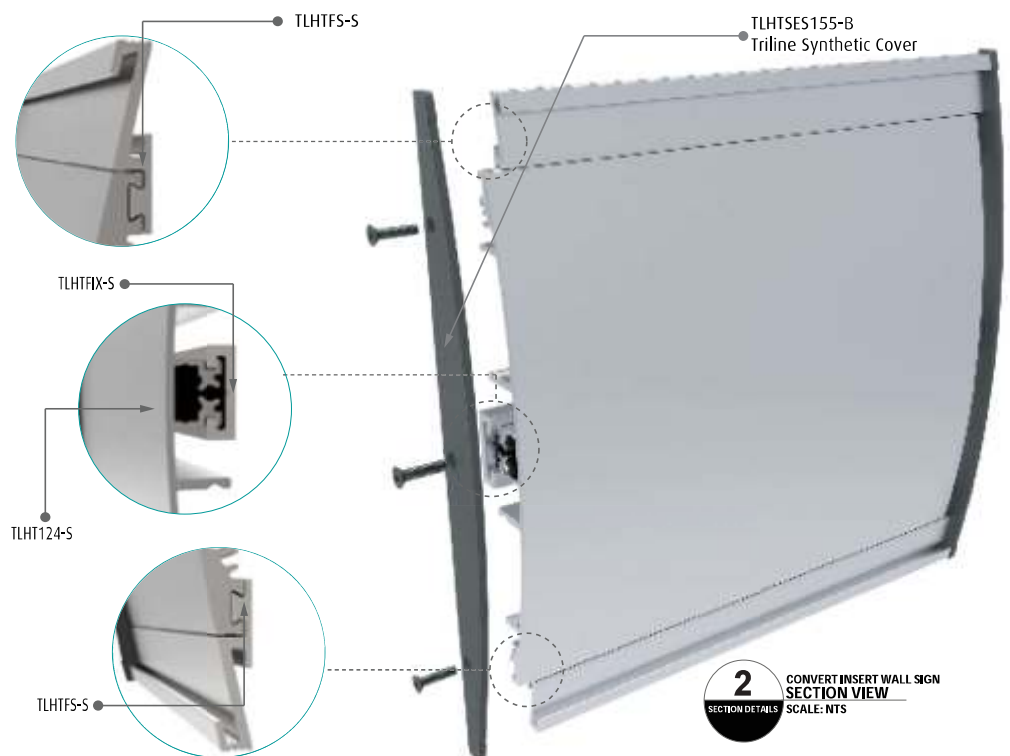

## Convex Insert Wall Sign (DIN)

With the convex profile TLHT217 and the insert profiles TLHTSFRA3 or TLHTSFEA3 (round and ellipse) you can create an insert sign in A3. Finish with synthetic single endcaps round or ellipse. Easy assembly.

Ideal for personnel signs, room identification, wall projection signs, emergency signage, evacuation maps and more.



COMPONENTS	
A	TLHT217-S
B	TLHTSFEA3-S
C	TLHTSER297-S
D	TLHTFIX-S
E	TLSCR7-S
F	TLSCR8-S

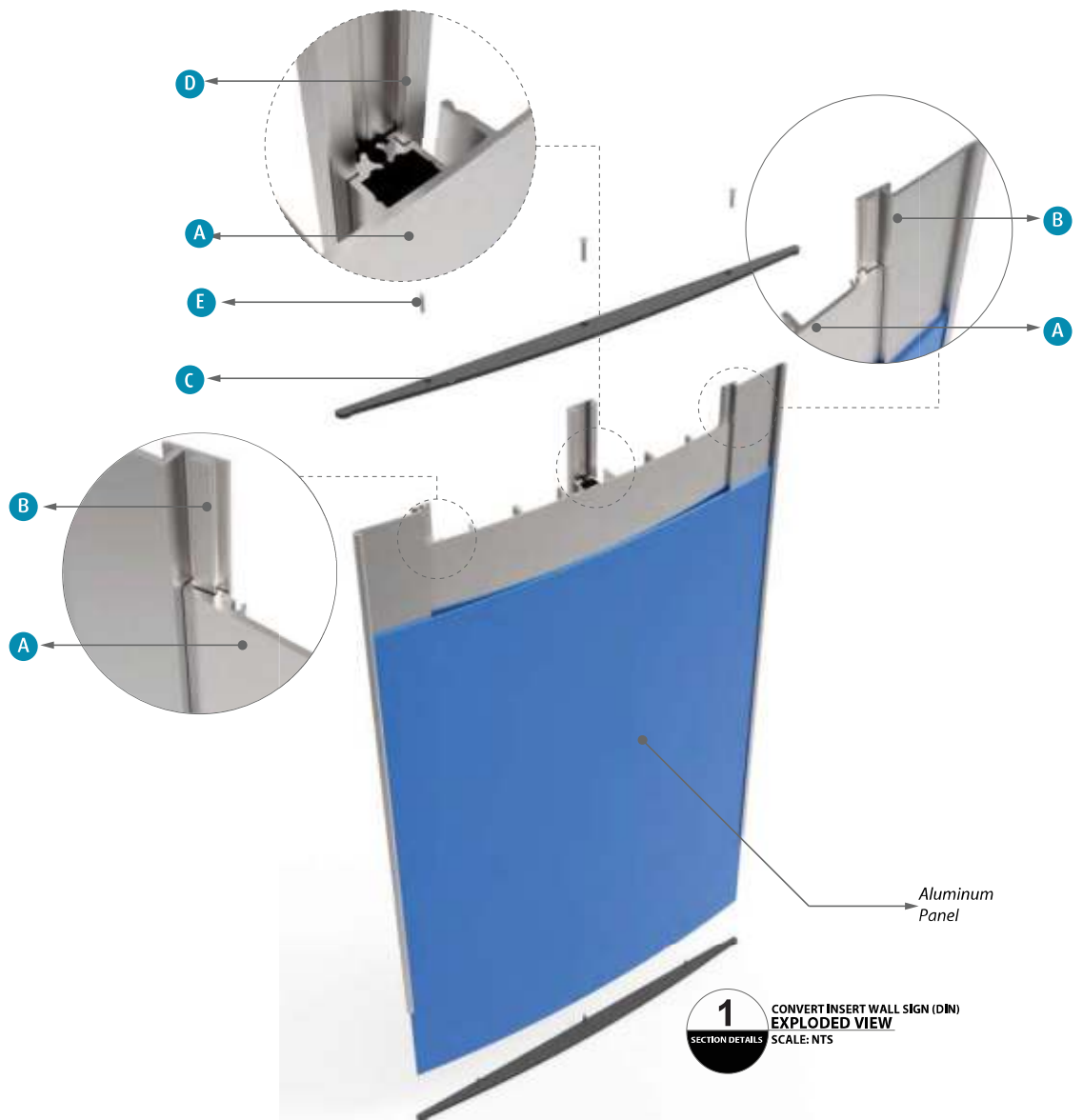

## CONVERT INSERT WALL SIGN (DIN)

### Assembly and Section Details

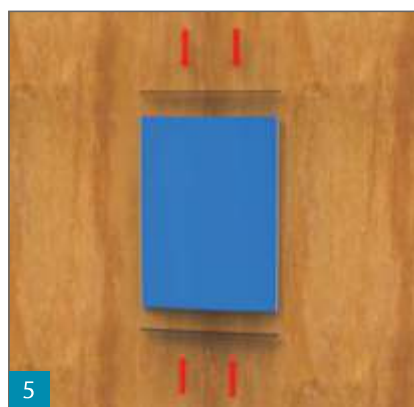
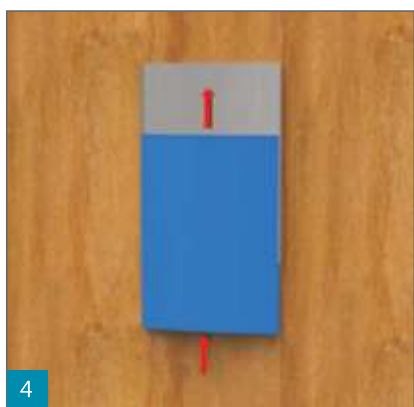
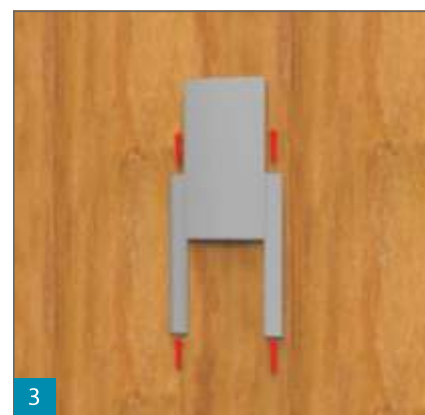
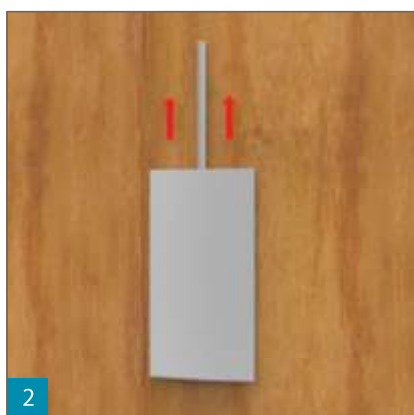
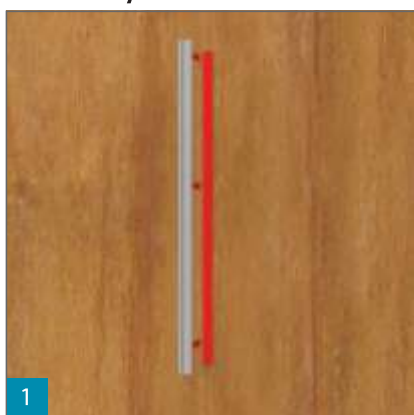

APPLICATIONS
* Personal Signs
* Room Identifications
* Wall Projections Signs
* Emergency Signs

MOUNTING POSSIBILITIES
* With double adhesive for wall mounting.

SECTION DETAILS
* Using TLHTFIX-S basic colors: - Silver - Gray
* PROFILES have standard length of 3500 mm
* Standard Finish: - Mill - Silver Anodized

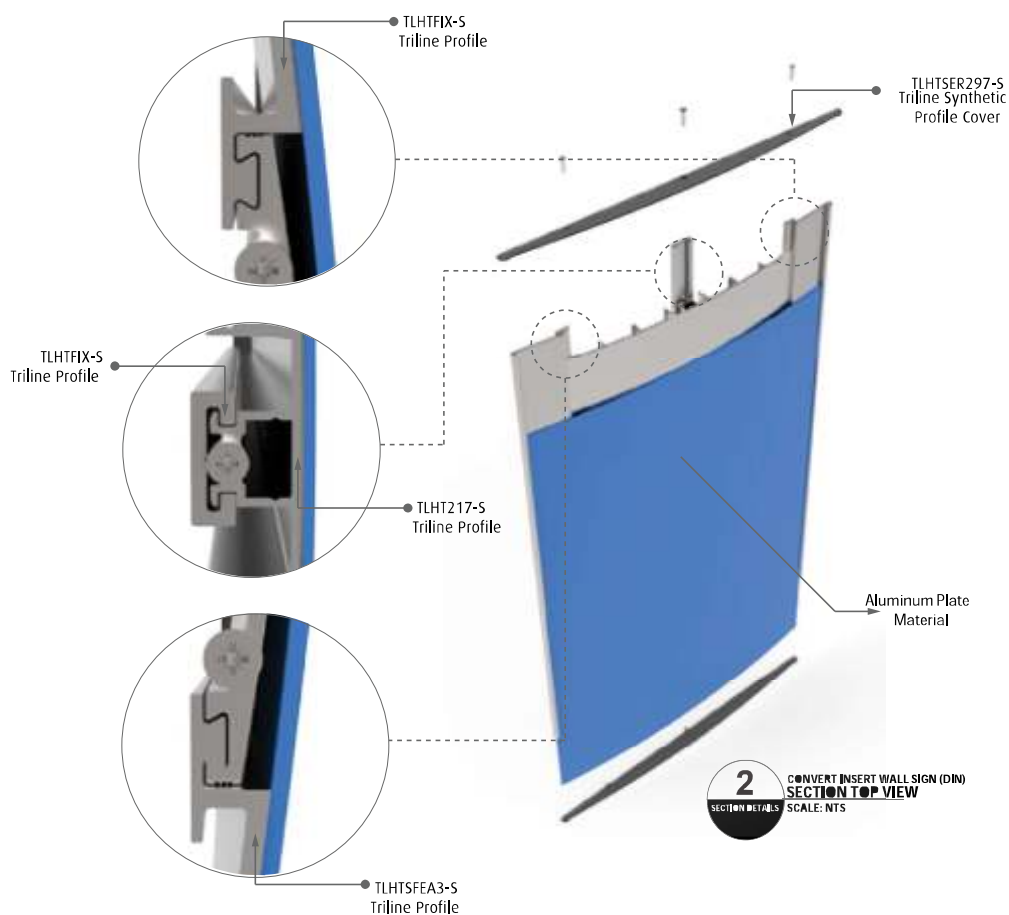

**2** SECTION DETAILS  
CONVERT INSERT WALL SIGN (DIN)  
SECTION TOP VIEW  
SCALE: NTS





## CONVERT DIRECTORY SIGN

### Assembly and Section Details

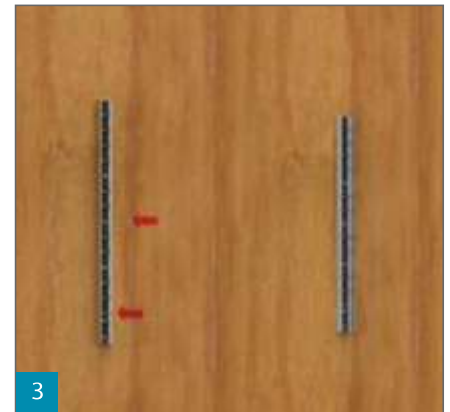
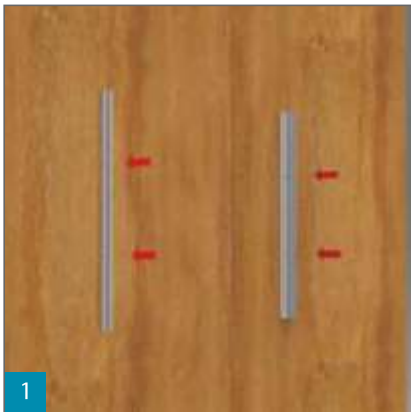

■ APPLICATIONS
<ul style="list-style-type: none"> <li>* Personal Signs</li> <li>* Room Identifications</li> <li>* Wall Projections Signs</li> <li>* Emergency Signs</li> </ul>
■ MOUNTING POSSIBILITIES
<ul style="list-style-type: none"> <li>* With double adhesive for wall mounting.</li> <li>* Screw plugs for stability</li> </ul>
■ SECTION DETAILS
<ul style="list-style-type: none"> <li>* Using TLCLI Clips basic colors:                             <ul style="list-style-type: none"> <li>- Silver</li> <li>- Gray</li> </ul> </li> <li>* PROFILES have standard length of 3500 mm</li> <li>* Standard Finish:                             <ul style="list-style-type: none"> <li>- Mill</li> <li>- Silver Anodized</li> </ul> </li> </ul>

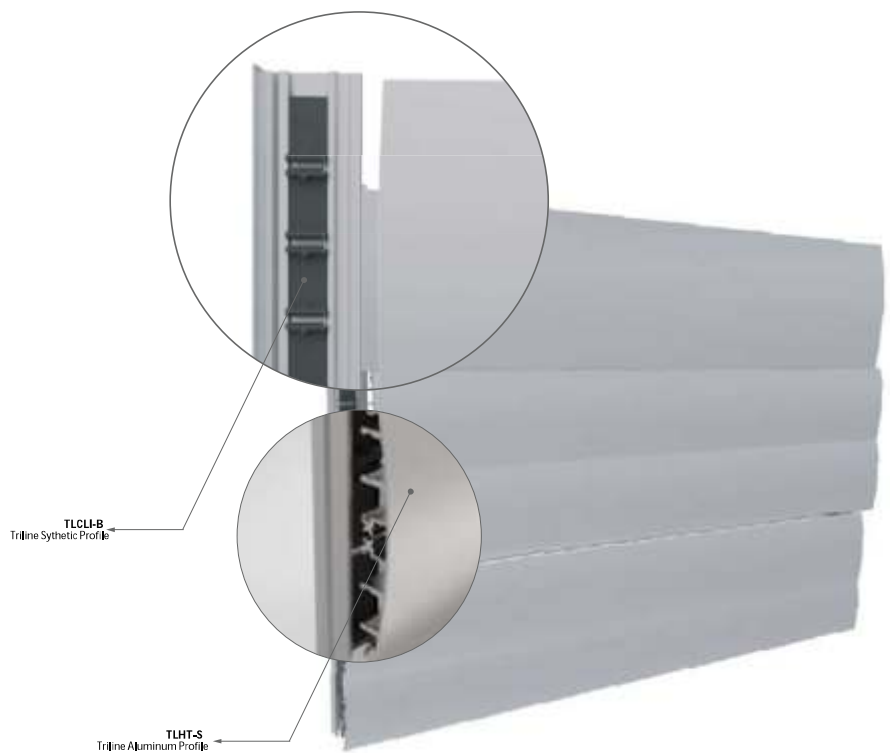

**2** CONVEX DIRECTORY SIGN  
SECTION VIEW  
SCALE: NTS

## Convex Suspended Sign

Slide two convex profile on the post TLHTP26. Add on the top and bottom insert profile TLHTSF of your choice, and consequently the suspension system TLOPH. Finish the sign with 2 mm double aluminium endcaps, from 93 to 297 mm. With connector TLHTCD you can extend your suspension sign.

Room identification, directories, directional signs and more...

This type of sign complies with suspension-safety regulations for public buildings.



**COMPONENTS**

-  **TLOPH**
-  **TLHTADE186-B**
-  **TLHT186-S**
-  **TLHTCON-S**
-  **TLHTP26-S**
-  **TLHTC-S**
-  **TLSCR7-S**
-  **TLSCR8-S**

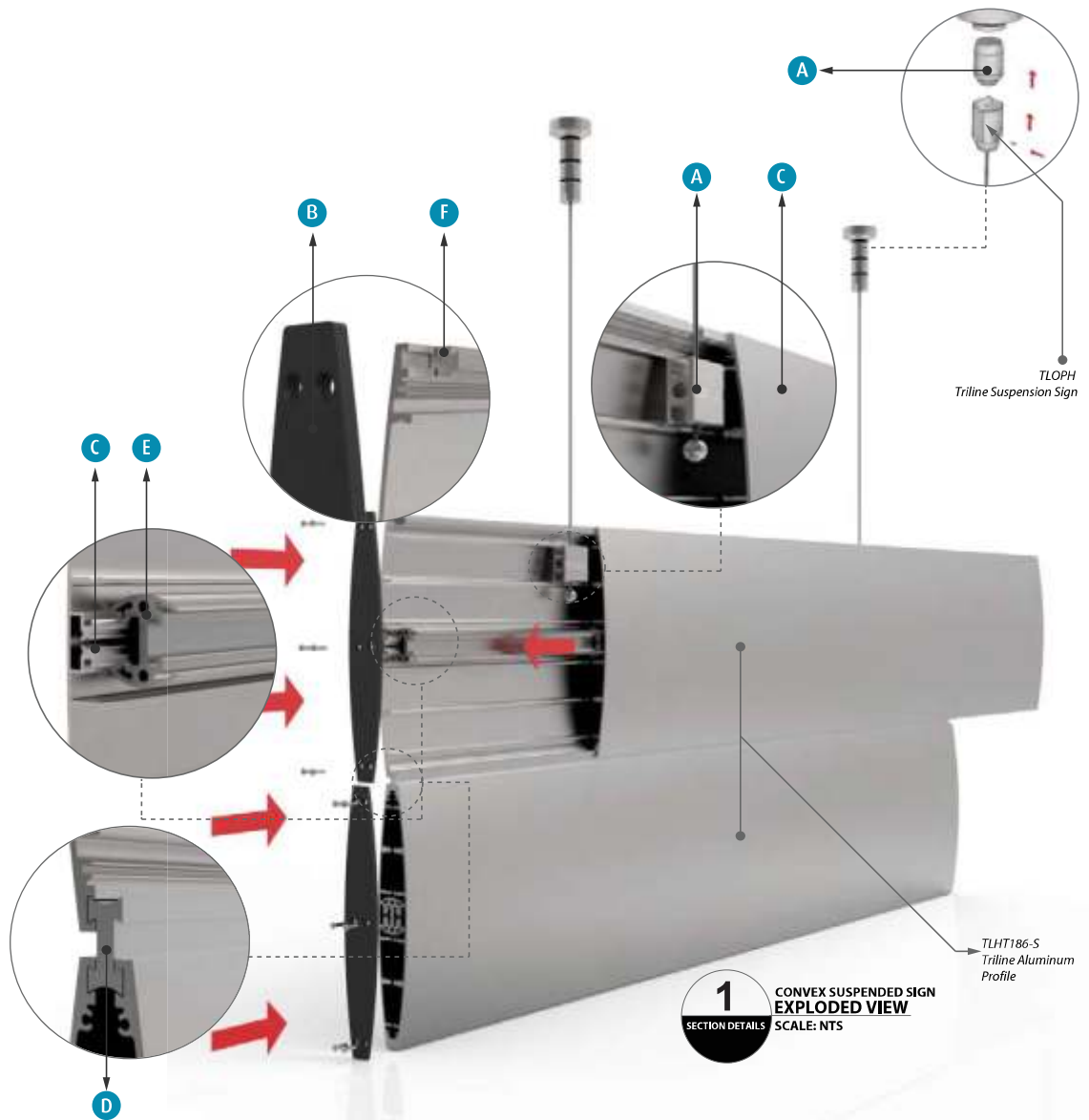

## CONVERT SUSPENDED SIGN

### Assembly and Section Details



#### ■ APPLICATIONS

- \* Room Identification
- \* Directory Sign
- \* Emergency Signs

#### ■ MOUNTING POSSIBILITIES

- \* With TLOPH suspension Wire Hanging Sign
- \* Screw plugs for stability

#### ■ SECTION DETAILS

- \* Using TLHTCON for double hanging sign:  
basic colors:  
- Silver  
- Gray
- \* PROFILES have standard length of 93 - 297mm
- \* Standard Finish:  
- Mill  
- Silver Anodized

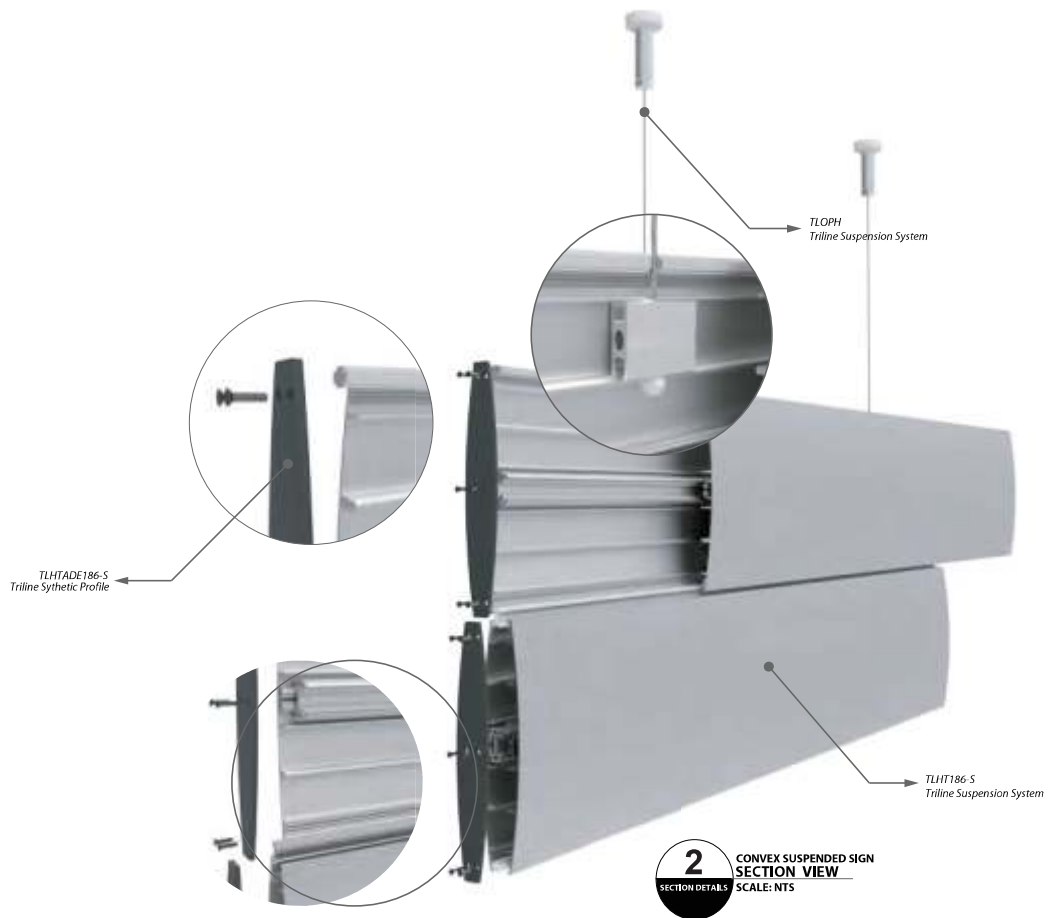

**2** CONVEX SUSPENDED SIGN  
SECTION VIEW  
SCALE: NTS

## Convex Insert Totem (Recto-Verso)

Fix the post TLHTP26 to the elliptical base with TLSCR1.  
Insert the convex profile that you desire and use cover profile TLHTC to close the open space left & right side.

Close top of the double sided totem with double aluminium endcap with TLSCR7/8 screws.

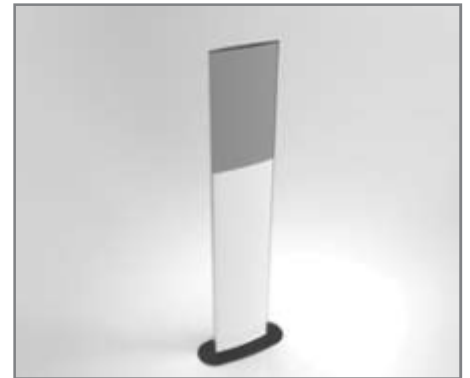

**COMPONENTS**

- A**  **TLHTADER186-B**
- B**  **TLHT186-S**
- C**  **TLHTP26-S**
- D**  **TLHTSFEA3-S**
- E**  **TLSCR7-S**
- F**  **TLSCR8-S**



# CONVEX INSERT TOTEM (RECTO -VERSO)

## Assembly and Section Details

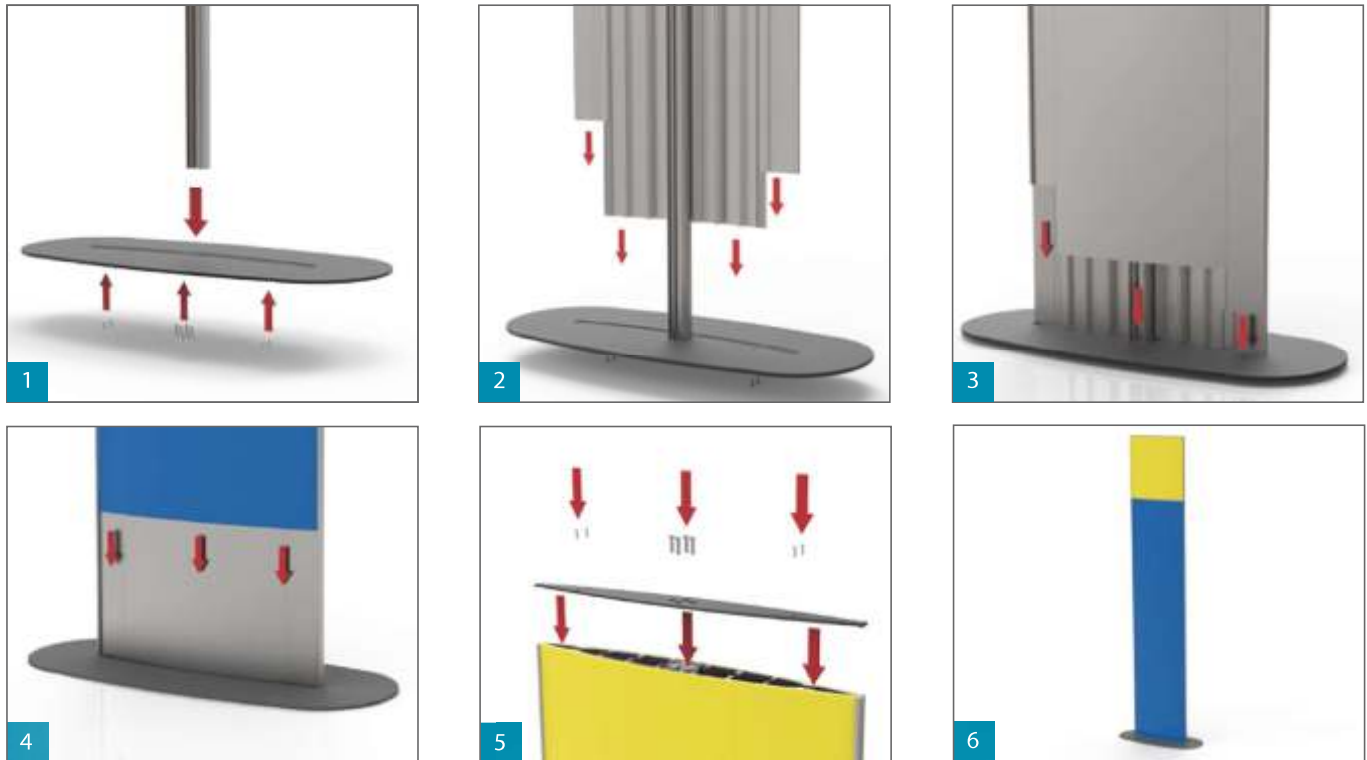

- APPLICATIONS**
  - \* Information Sign
  - \* Directional Sign
  - \* Regulatory Signs etc.
- MOUNTING POSSIBILITIES**
  - \* Interior Signs for Totem with base plate.
- SECTION DETAILS**
  - \* Using TLHTP26 as electrical base screws as base plate.
  - \* PROFILES have standard length of 3500 mm
  - \* Standard Finish:
    - Mill
    - Silver Anodized

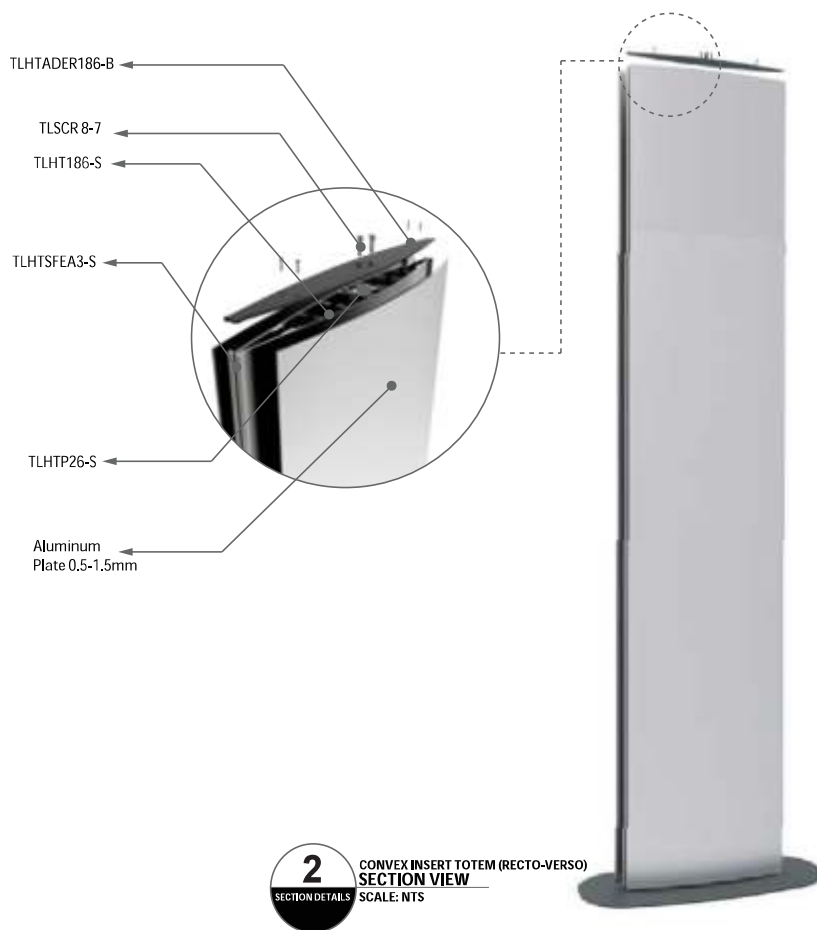



**2** CONVEX INSERT TOTEM (RECTO-VERSO)  
SECTION VIEW  
SCALE: NTS

### Convex Insert Totem (Triangle)

Fix three posts TLHTP26 to the triangular base with TLSCR1.  
 Insert the convex profile that you desire and, after, slide the insert profile TLHTSF of your choice.  
 Close the triangular totem with 2 mm triangular aluminium endcap and screws.



**COMPONENTS**

- A**  **TLTRIA3**
- B**  **TLHTMWA3-S**
- C**  **TLHTMWSUP-S**
- D**  **TLTBASETRIA3**
- E**  **TLSCR5 & 9-S**

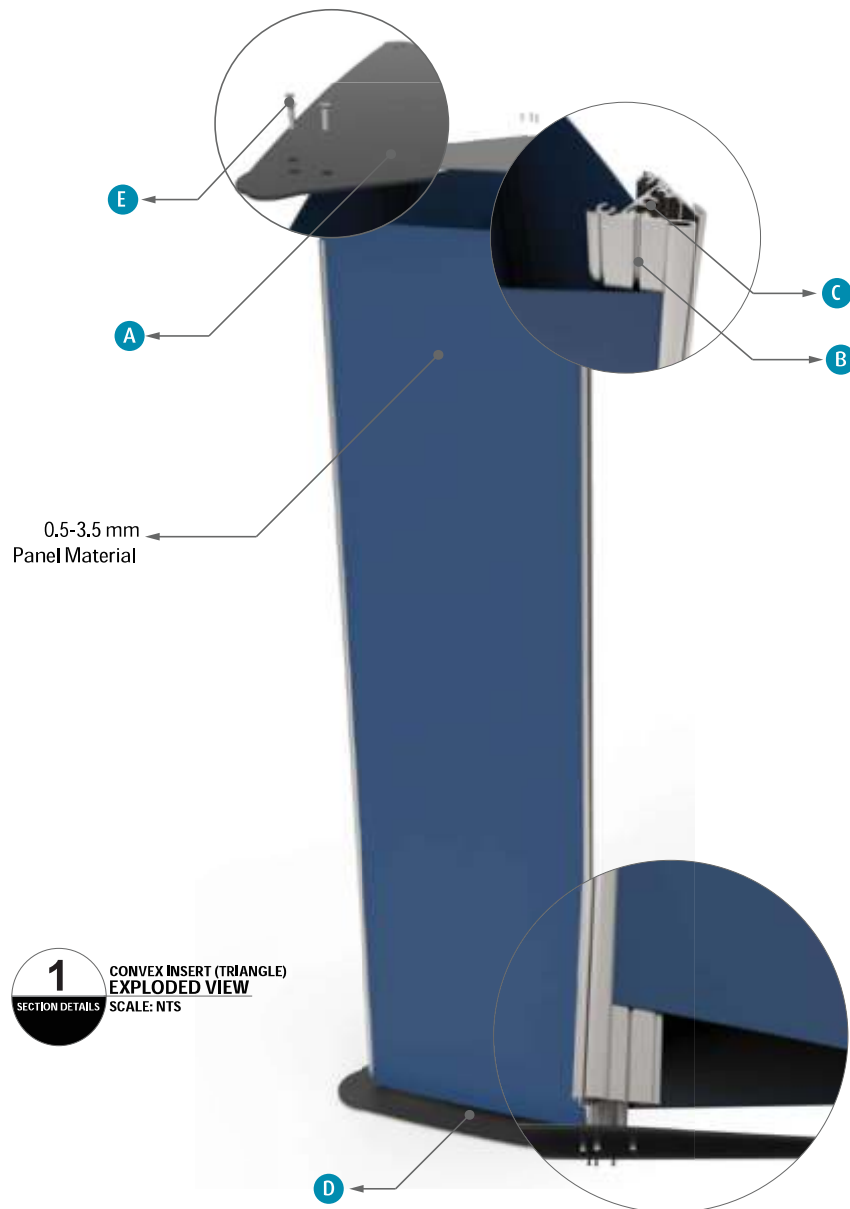

## CONVEX INSERT TOTEM (TRIANGLE)

### Assembly and Section Details

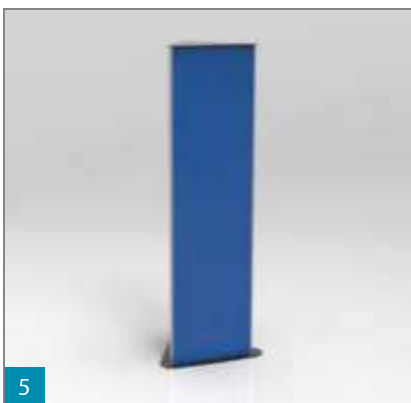
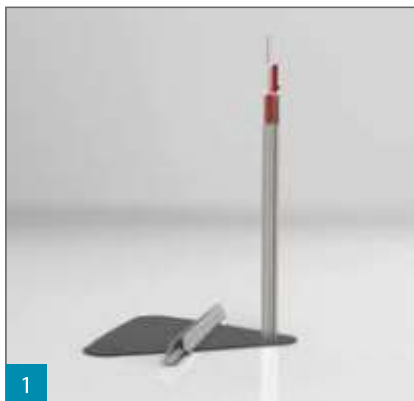

■ APPLICATIONS
<ul style="list-style-type: none"> <li>* Information Sign</li> <li>* Directional Sign</li> <li>* Regulatory Signs etc.</li> </ul>
■ MOUNTING POSSIBILITIES
<ul style="list-style-type: none"> <li>* Interior Signs for Totem with base plate.</li> </ul>
■ SECTION DETAILS
<ul style="list-style-type: none"> <li>* Using TLHTP26 as electrical base screws as base plate.</li> <li>* PROFILES have standard length of 3500 mm</li> <li>* Standard Finish:                             <ul style="list-style-type: none"> <li>- Mill</li> <li>- Silver Anodized</li> </ul> </li> </ul>

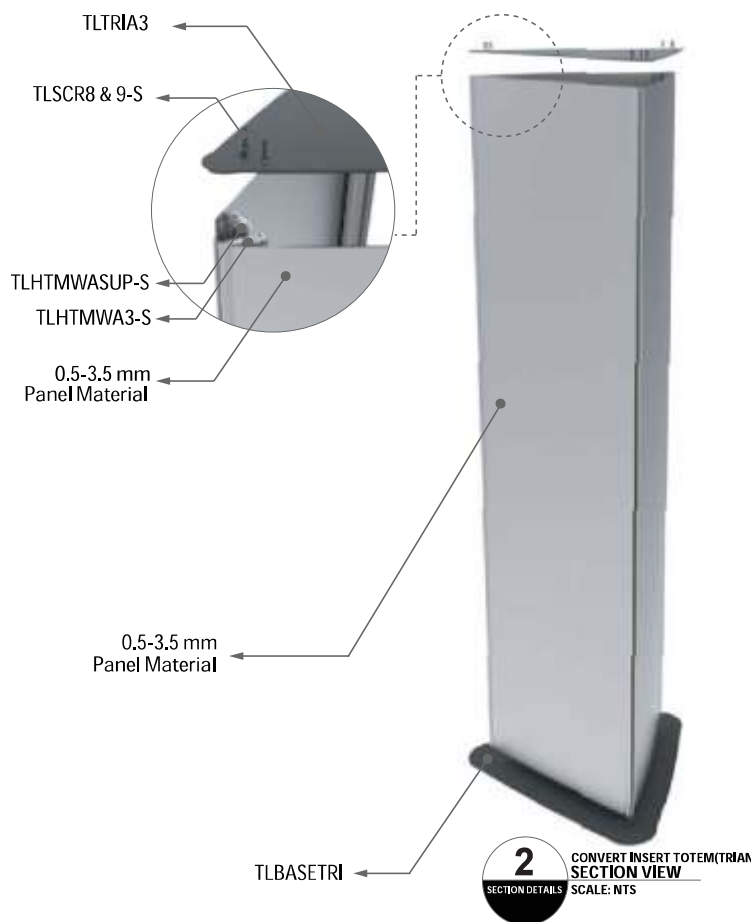

### Convex Insert Totem (Square)

Fix the four posts TLHTP26 to the square base with TLSCR1.  
 Insert the convex profile that you desire and, after, slide the insert profile TLHTSF of your choice.  
 Close the square totem with 2 mm square aluminium endcap and screws.



**COMPONENTS**

- A**  **TLSQUARE3**
- B**  **TLHTMWA3-S**
- C**  **TLHTMWSUP-S**
- D**  **TLBASESQA3**
- E**  **TLSCR9 & TLSCR5-S**

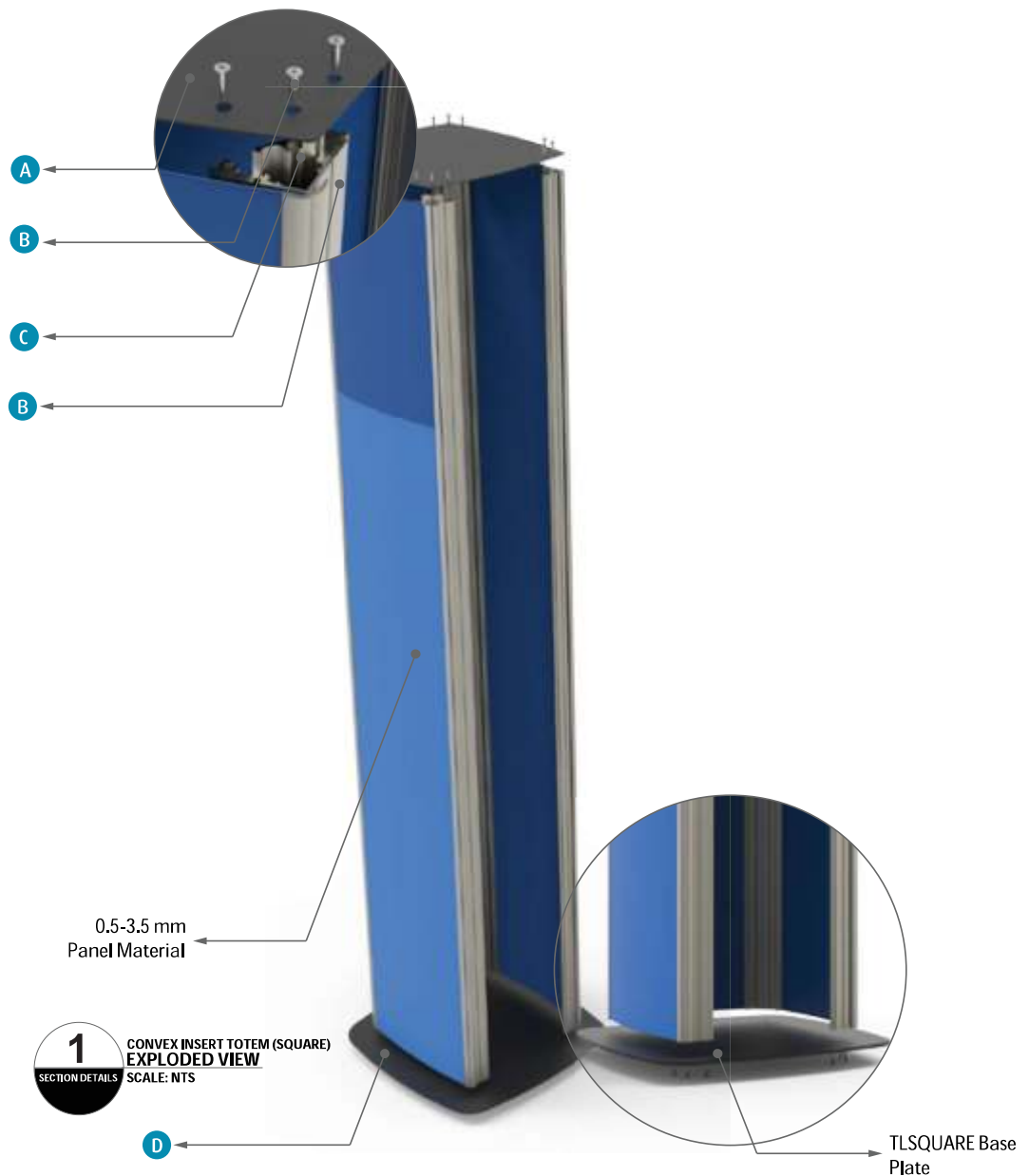



## CONVEX INSERT TOTEM (SQUARE)

### Assembly and Section Details

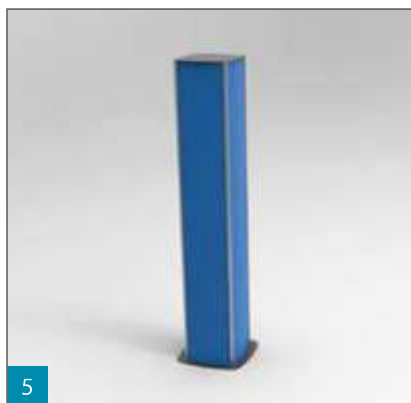
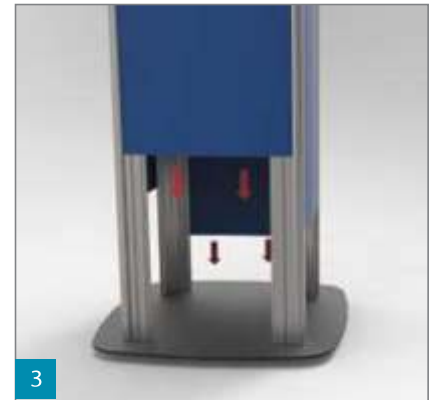
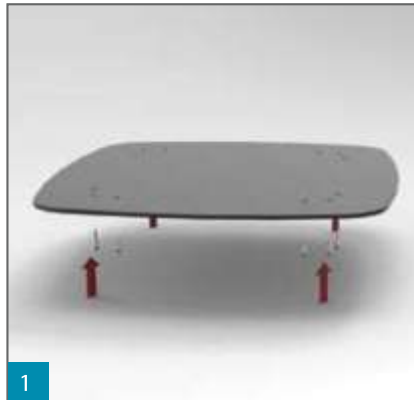

<b>■ APPLICATIONS</b>
<ul style="list-style-type: none"> <li>* Information Sign</li> <li>* Directional Sign</li> <li>* Regulatory Signs etc.</li> </ul>
<b>■ MOUNTING POSSIBILITIES</b>
<ul style="list-style-type: none"> <li>* Interior Signs for Totem with base plate.</li> </ul>
<b>■ SECTION DETAILS</b>
<ul style="list-style-type: none"> <li>* Using TLHTP26 as eleptical base screws as base plate.</li> <li>* PROFILES have standard lenght of 3500 mm</li> <li>* Standard Finish:                             <ul style="list-style-type: none"> <li>- Mill</li> <li>- Silver Anodized</li> </ul> </li> </ul>

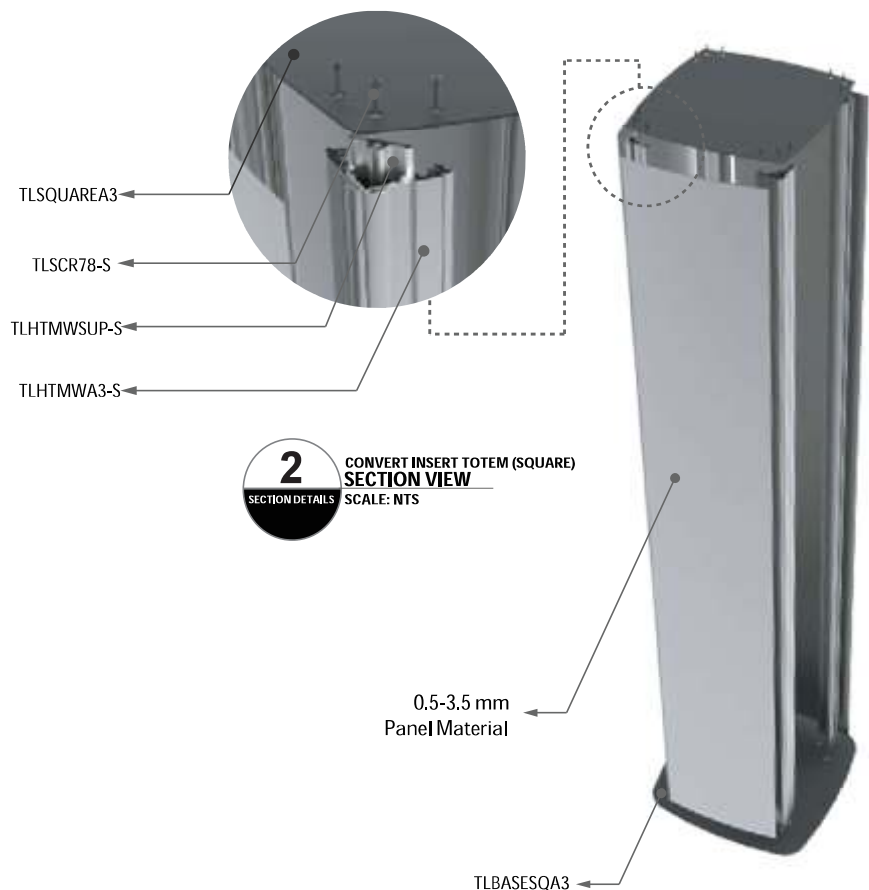

## Convex Insert Totem (Hexagon)

Fix the six posts TLHTP26 to the hexagon base with TLSCR1.  
Insert the convex profile that you desire and, after, slide the insert profile TLHTSF of your choice.  
Close the hexagon totem with 2 mm square hexagon endcap and screws.



**COMPONENTS**

- A**  **TLHEXAGA3**
- B**  **TLHTMWA-S**
- C**  **TLHTMWSUP-S**
- D**  **TLTBASEHEXA3**
- E**  **TLSCR 7 & 8-S**

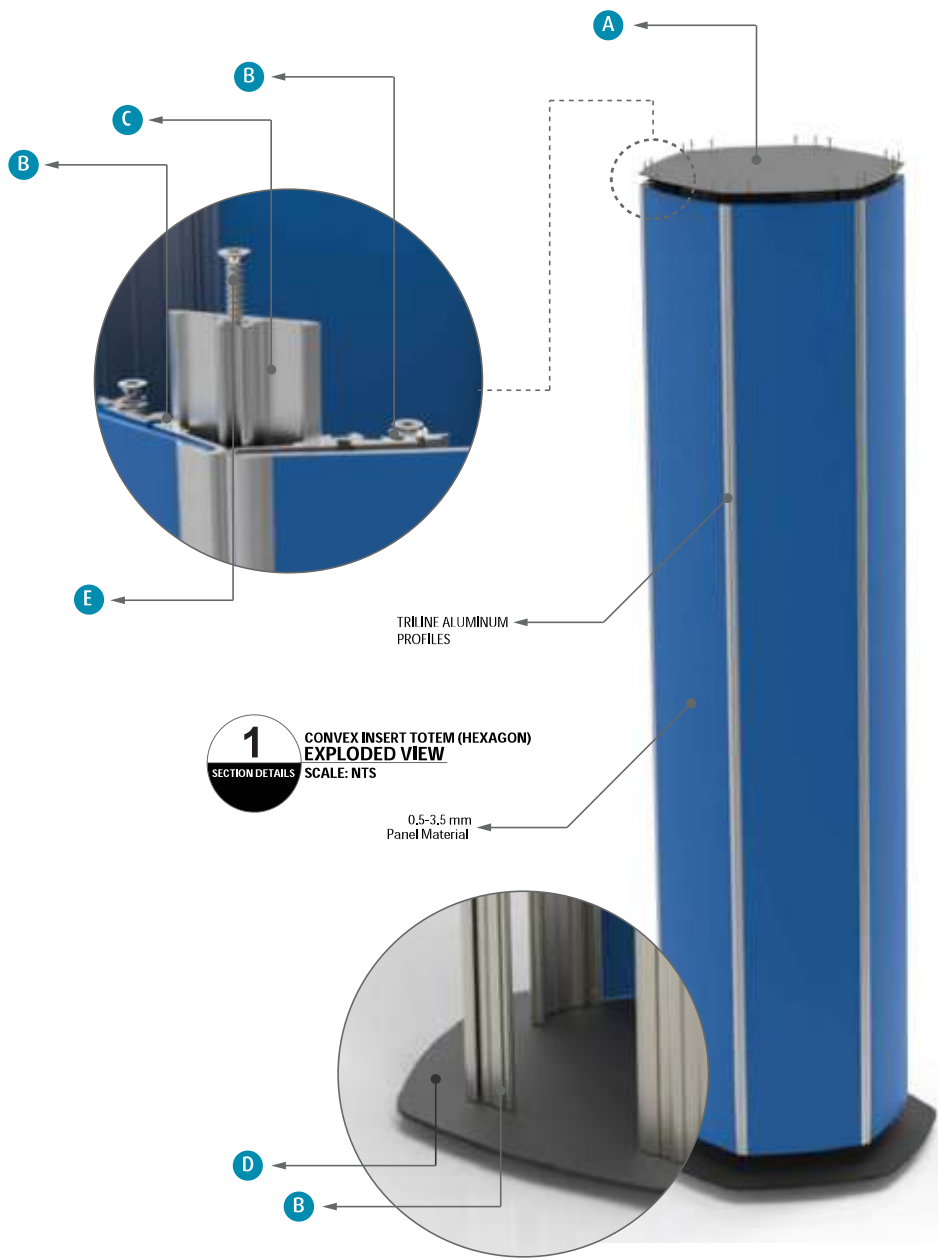

# CONVEX INSERT TOTEM (HEXAGON)

## Assembly and Section Details

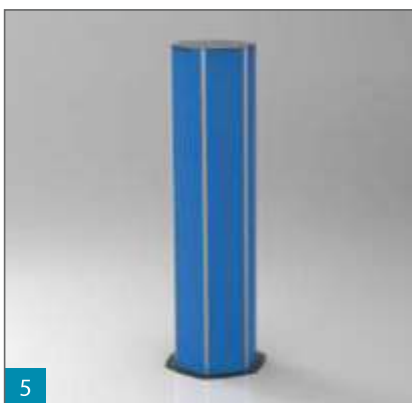
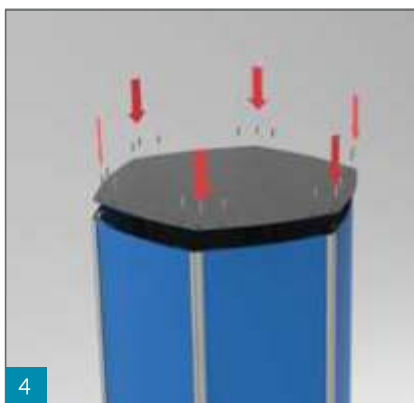
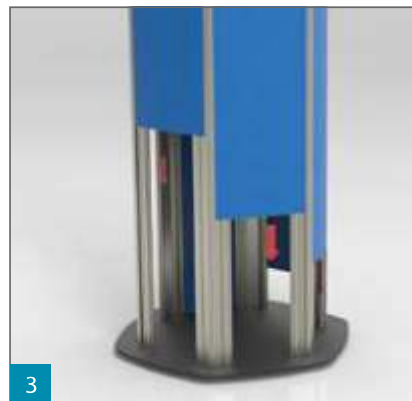
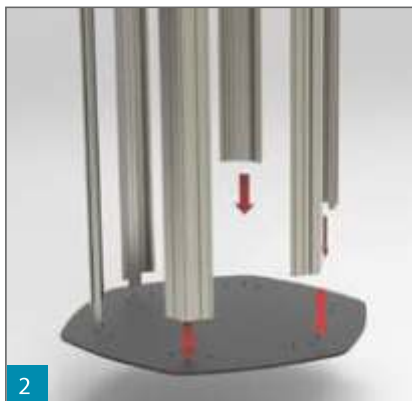

<b>■ APPLICATIONS</b>
<ul style="list-style-type: none"> <li>* Information Sign</li> <li>* Directional Sign</li> <li>* Regulatory Signs etc.</li> </ul>
<b>■ MOUNTING POSSIBILITIES</b>
<ul style="list-style-type: none"> <li>* Interior Signs for Totem with base plate.</li> </ul>
<b>■ SECTION DETAILS</b>
<ul style="list-style-type: none"> <li>* Using TLHTP26 as electrical base screws as base plate.</li> <li>* PROFILES have standard length of 3500 mm</li> <li>* Standard Finish:                             <ul style="list-style-type: none"> <li>- Mill</li> <li>- Silver Anodized</li> </ul> </li> </ul>

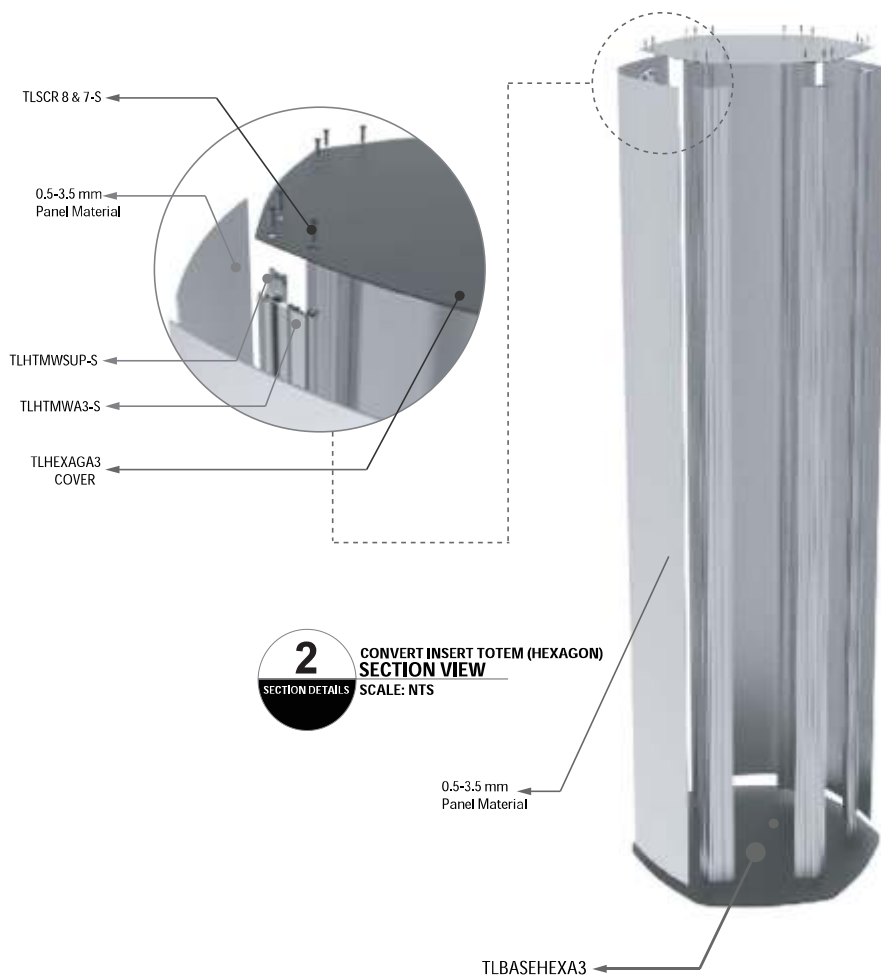

## Convex Insert Flag Sign

Fix post TLHTP26 to aluminium base TLHTADU (4mm thickness) with TLSCR1, next fix it to the wall with 2 screws. Insert convex profile to the post. Slide the insert profile TLHTSF in the convex profile. The flag sign is finished with 2 mm double aluminum endcap (from 93 to 297mm) fixed with screws.

Extend your flag sign with double connector TLHTCD (available in 3 different looks, square round or ellipse). Room identification, directories, directional signs and more...



**COMPONENTS**

- A

**TLHTADES186-B**
- B

**TLHTSFS-S**
- C



**TLHT155-S**
- D

**TLHTP26-S**
- E

**TLHTCDS-S**
- F

**TLHTADU186-B**
- G

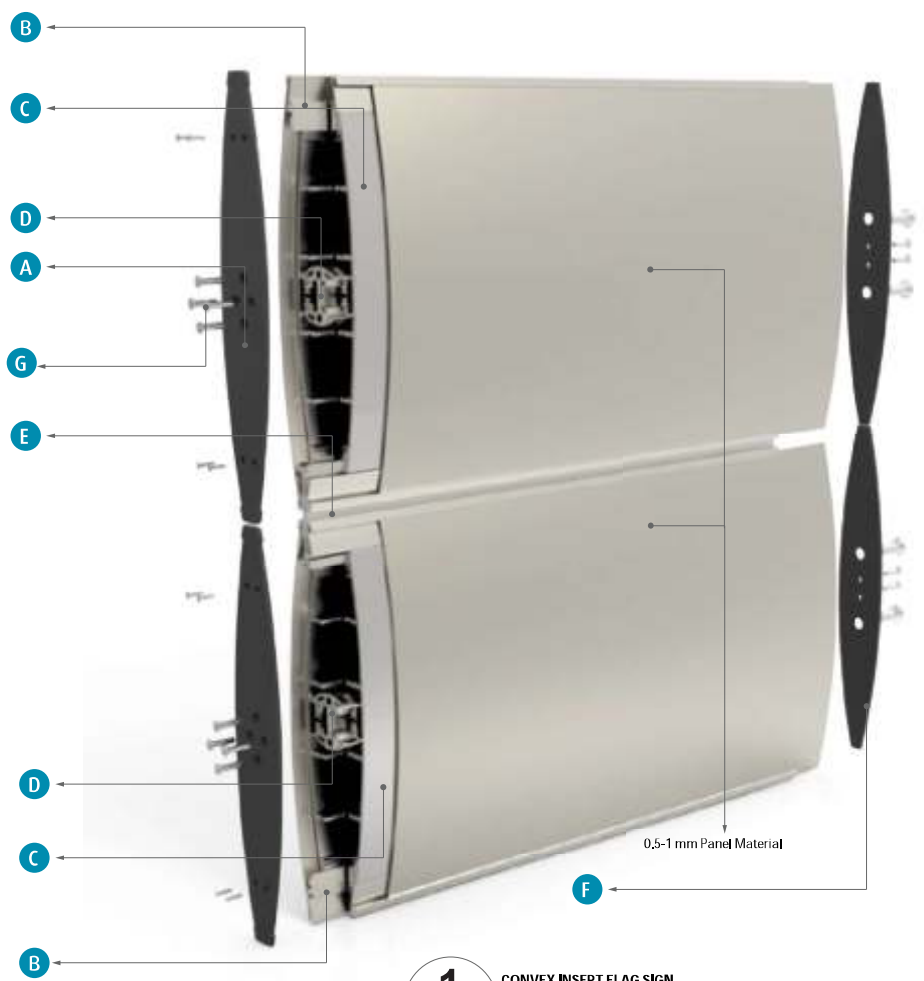

**TLSCR 7 & 8-S**



**1** CONVEX INSERT FLAG SIGN  
EXPLODED VIEW  
SCALE: NTS  
SECTION DETAILS

# CONVEX INSERT(FLAG SIGN)

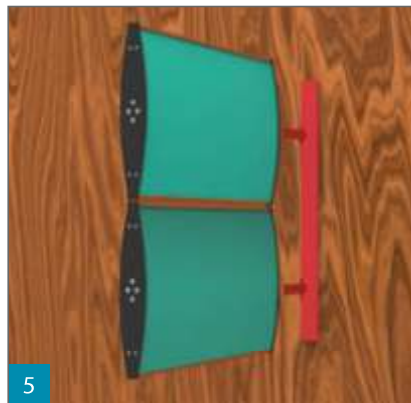
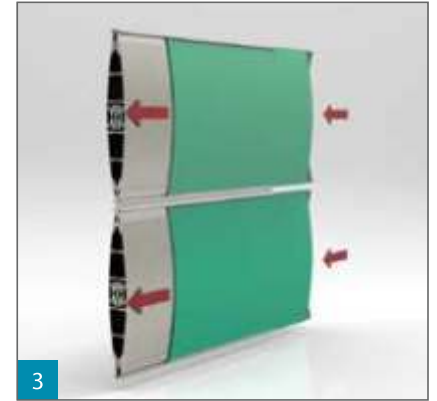
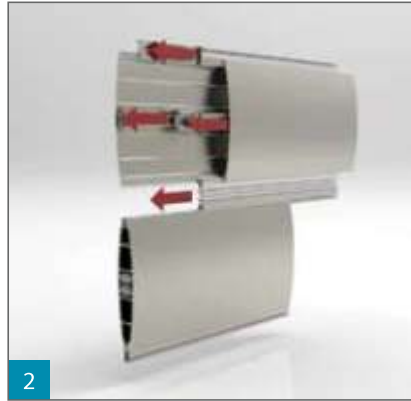
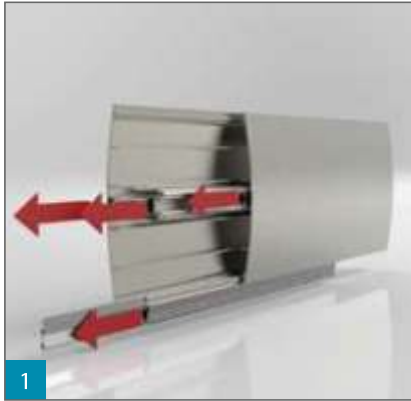
## Assembly and Section Details



■ APPLICATIONS
<ul style="list-style-type: none"> <li>* Information Sign</li> <li>* Room Identification</li> <li>* Directional Sign</li> <li>* Regulatory Signs etc.</li> </ul>
■ MOUNTING POSSIBILITIES
<ul style="list-style-type: none"> <li>* Interior Signs for Totem Flag Sign</li> </ul>
■ SECTION DETAILS
<ul style="list-style-type: none"> <li>* Using TLHTADU186 as eleptical base screws as base plate.</li> <li>* PROFILES have standard length of 3500 mm</li> <li>* Standard Finish:                         <ul style="list-style-type: none"> <li>- Mill</li> <li>- Silver Anodized</li> </ul> </li> </ul>

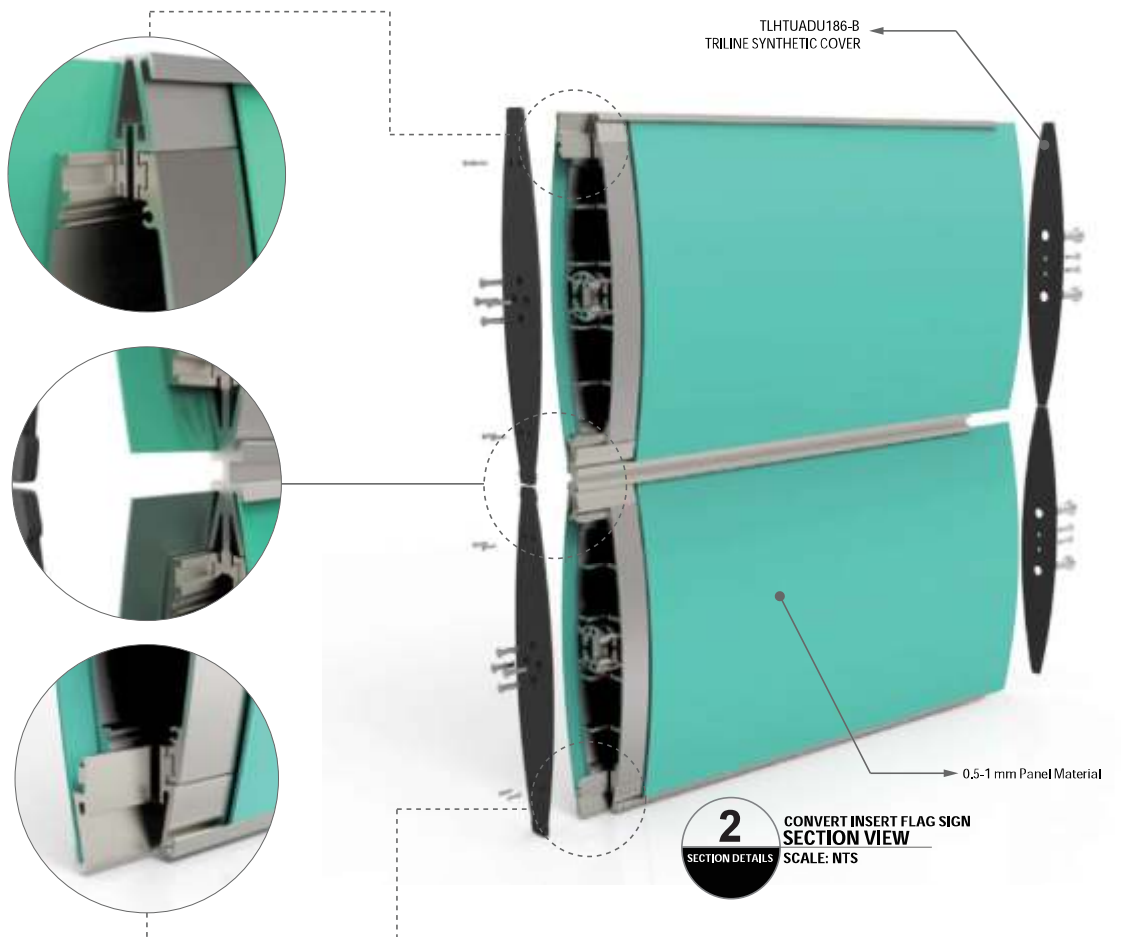









## Convex Flag Sign + Tripost™

Using the profile (G) TLHTCPWI Triline has made the Hi-Tech™ more versatile. It can be used in Internal & External Signs, making the application possibilities wider.

TriPost™ columns are available up to \*4 meters.



**COMPONENTS**

-  **A**  
TLHTADE186-B
-  **B**  
TLHTP26-S
-  **C**  
TLHT186-S
-  **D**  
TLHTCPWI-S
-  **E**  
TLHTC-S
-  **F**  
TLOPV-S
-  **G**  
TLPR90-S
-  **H**  
TLDOPR90-B
-  **I**  
TLSCR 7 & 8-S

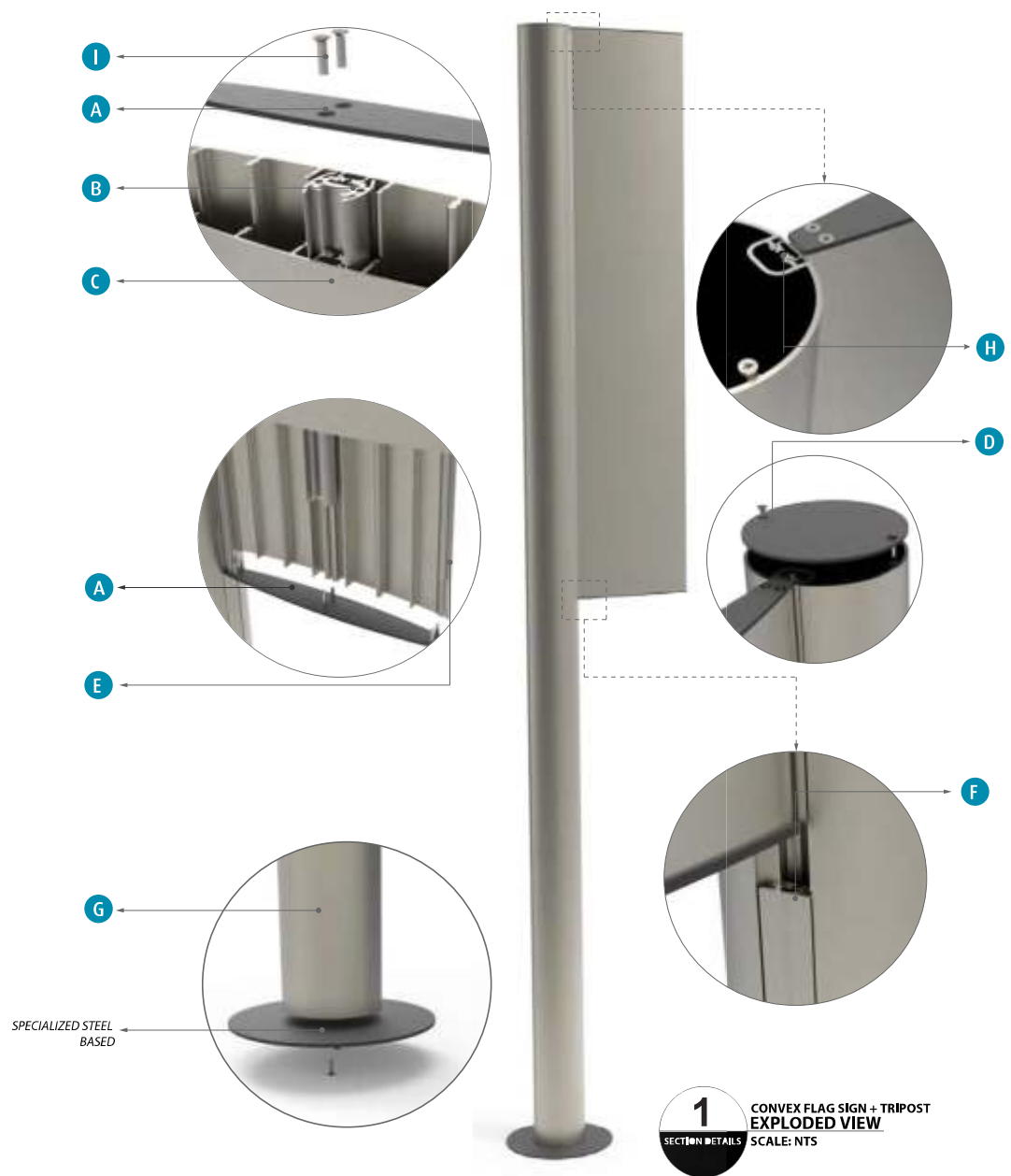

## CONVEX INSERT(FLAG SIGN)

### Assembly and Section Details

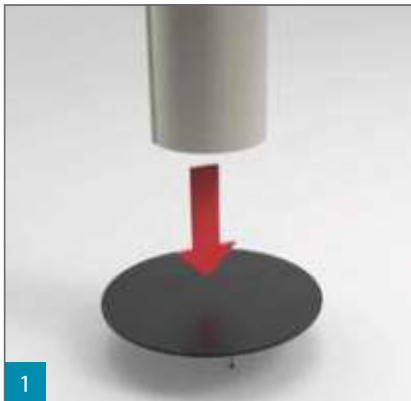

**APPLICATIONS**

- \* Information Sign
- \* Room Identification
- \* Directional Sign
- \* Regulatory Signs etc.

**MOUNTING POSSIBILITIES**

- \* Interior Signs for Totem Flag Sign

**SECTION DETAILS**

- \* Using TLHTADE186 as flag sign cover
- \* base screws as base plate.
- \* PROFILES have standard length of 3500 mm
- \* Standard Finish:
  - Mill
  - Silver Anodized

